

9290 008 65208

Brand Name	XITANIUM
Description	Xitanium 75W 0.70A 230V-Y cXt
Input Voltage	220~240V
Input Frequency	50/60Hz
RoHS	Yes
Status	Released

Electrical Specifications

Output Power (W)	Output Voltage (V)	Output Current (A)	Efficiency@ Max Load			Max Case Temp. (°C)	Input Current			Max. Input Power (W)	Inrush Current (A _{in} /50%- μ s)		THD @ Max Load (%)	Power Factor @ Max Load	Surge Protection Common/Diff (KV/2ohm)	Weight (kgs)
			220 V	230 V	240 V		2.0 0v	2.2 0v	2.40v		220 Vin	32/389				
75	53 ~ 107	0.7	90.7	90.8	90.9	80 °C	0.42	0.38	0.34	87	220 Vin	32/389	15	>0.95	4/4	0.63

Wire Diagram

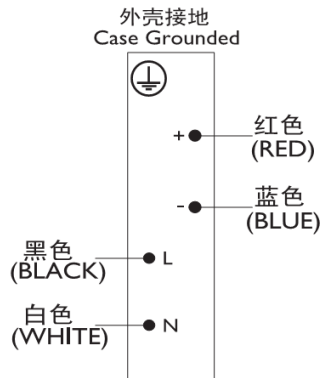

Input and output use lead-wires.

Lead-wires are 18AWG 105C/600V solid copper.

Standard Lead Length is 315mm +/-10mm on all wires outside the can

Enclosure



	in. (mm)
Case Length	5.47 (139)
Case Width	2.36 (60)
Case Height	1.54 (39)
Mounting Length	5.98 (152)
Mounting Width	1.69 (43)
Overall Length	6.61 (168)



Revised 03/15/2013

Philips(China) Investment Co.,Ltd.
10F, Building I, 1535 Hongmei Road, Minghang District, Shanghai, 200233
Tel: 8008 201 201 · <http://www.lighting.philips.com.cn/>



9290 008 65208	
Brand Name	XITANIUM
Description	Xitanium 75W 0.70A 230V-Y cXt
Input Voltage	220~240V
Input Frequency	50/60Hz
RoHS	Yes
Status	Released

Electrical Specifications

Product Data	
Order code	9290 008 65208
Full product code	9290 008 65208
Full product name	Xitanium 75W 0.7A 230V-Y cXt
Net weight per piece	0.63kg
Interfaces	No
Ambient Temp Range	-40C to +55C
Corresponding Tcase	-15C to +80C
Shipment and Storage Temp	-40C to +80C
Shipment and Storage Humidity	10% to 95% RH
Line Voltage	220-240V (certified) and 85-305V (workable)
Line Current	0.38A/220V
Line Frequency	50/60Hz
Life @ TC 65 C	100,000 hr [nom] refer to graph below
Life @ TC 75 C	50,000 hr [nom] refer to graph below
Max TC	80C
Inrush current Width	Refer to table
Maximum ballast number on MCB 16A	11 [max]
Input Over-voltage	Can survive input over-voltage stress of 320VAC for 48 hours and 350VAC for 2 hours
LED Current Tolerance	+/-5%
Earth leakage current	0.7 mA [max]
Mains voltage safety (AC)	+/-10%
Mains voltage performance (AC)	+/-10%
Min. Mains voltage operational	198 V [min]
Output peak voltage	190V [max]
Output Current ripple	15% @ 700 mA (ripple = pk-pk/2 x avg)
THD total	< 20%
THD 3 rd Harmonic	< 15%
PF @ Max Load	>0.95
Wire Isolation	All wires are Double isolated to ground
Protections	Short Circuit and Open Circuit Protection for LED + and LED-

Installation & Application Notes:

Section I – Physical Characteristics

- 1.1 LED Driver shall be installed inside an electrical enclosure
- 1.2 External SPD has to be added to work with this driver in the luminaire design.
- 1.3 Wiring inside electrical enclosure shall comply with 600V/105°C rating or higher.

Section II – Performance

- 2.1 LED Driver has a rated lifetime of 50,000 hours @ TC ≤80C.
- 2.2 LED Driver tolerates sustained open circuit and short circuit output conditions without damage.
- 2.3 LED Driver maximum allowable case temperature is 80°C – see product label for measurement location.
- 2.4 LED Driver reduces output power to LEDs if its case temperature exceeds >90°C –thermal protection and eventually reduces output current to zero.
- 2.5 LED Driver complies with the requirements of CE, CISPR 15 Ed 7.2 and CQC.

Revised 03/15/2013



9290 008 65208	
Brand Name	XITANIUM
Description	Xitanium 75W 0.70A 230V-Y cXt
Input Voltage	220~240V
Input Frequency	50/60Hz
RoHS	Yes
Status	Released

Electrical Specifications

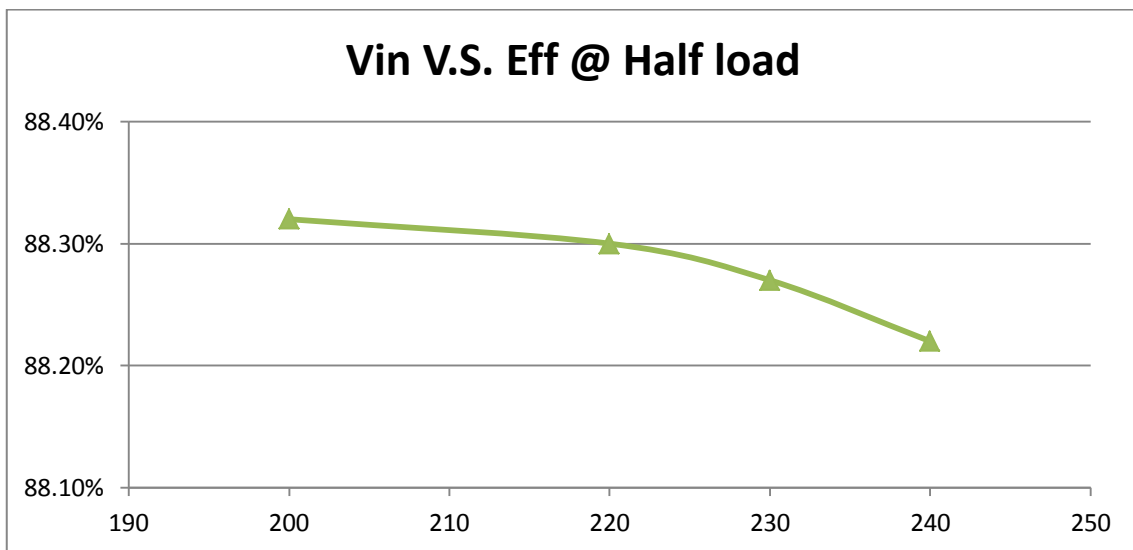
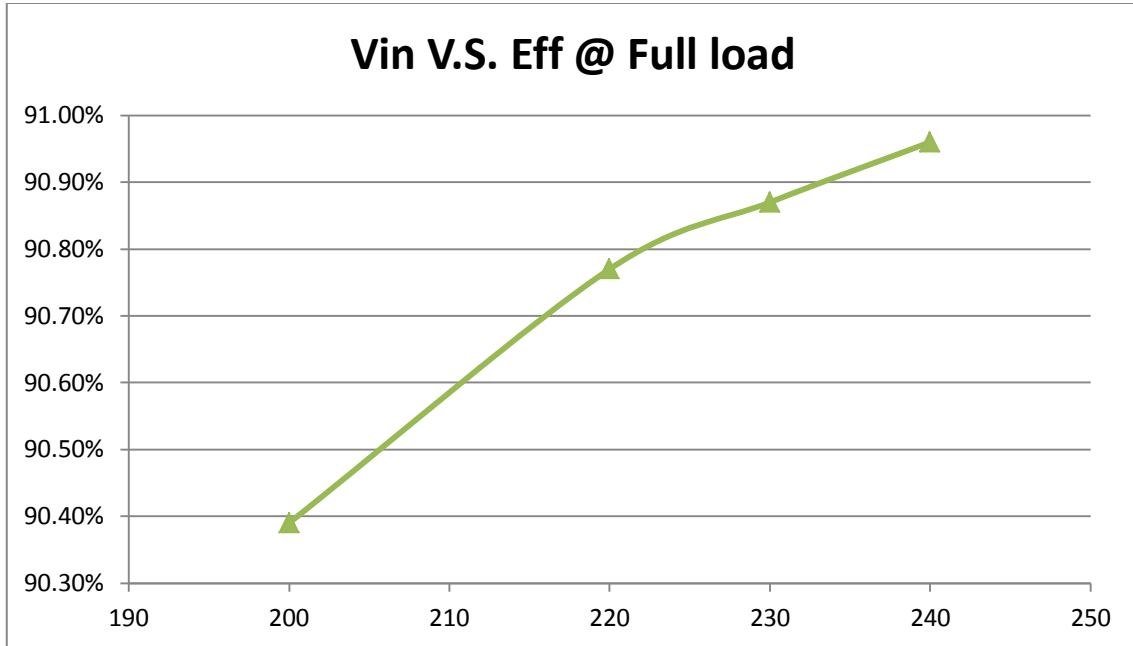

Revised 03/15/2013

9290 008 65208

Brand Name	XITANIUM
Description	Xitanium 75W 0.70A 230V-Y cXt
Input Voltage	220~240V
Input Frequency	50/60Hz
RoHS	Yes
Status	Released

Electrical Specifications

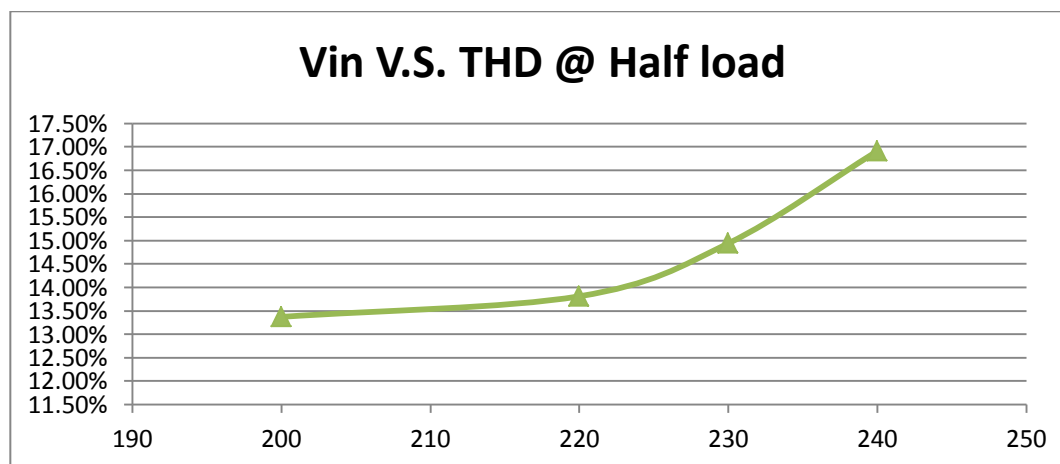
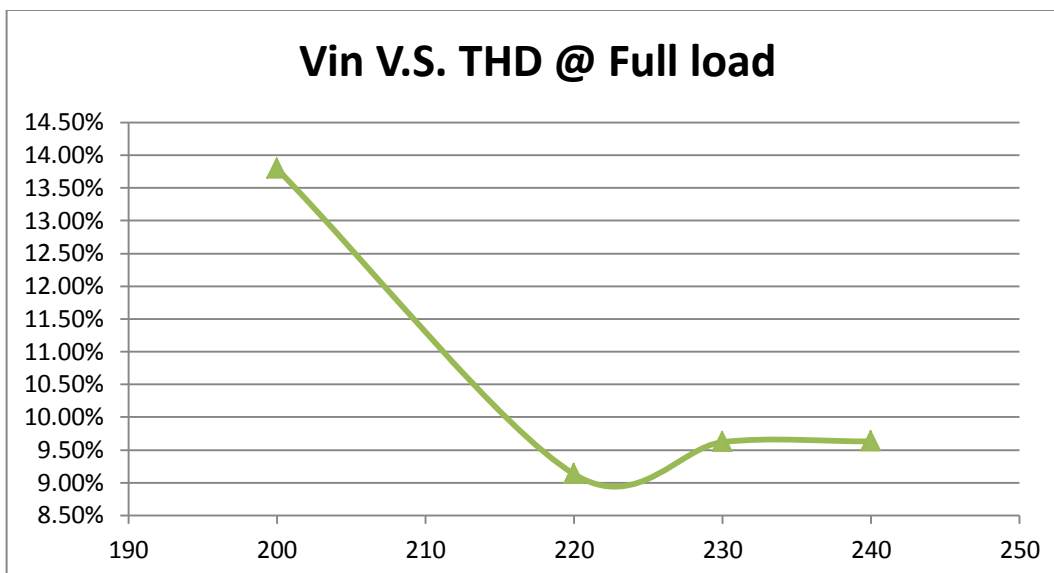

Revised 03/15/2013



9290 008 65208	
Brand Name	XITANIUM
Description	Xitanium 75W 0.70A 230V-Y cXt
Input Voltage	220~240V
Input Frequency	50/60Hz
RoHS	Yes
Status	Released

Electrical Specifications

Performance vs. Ambient temperature

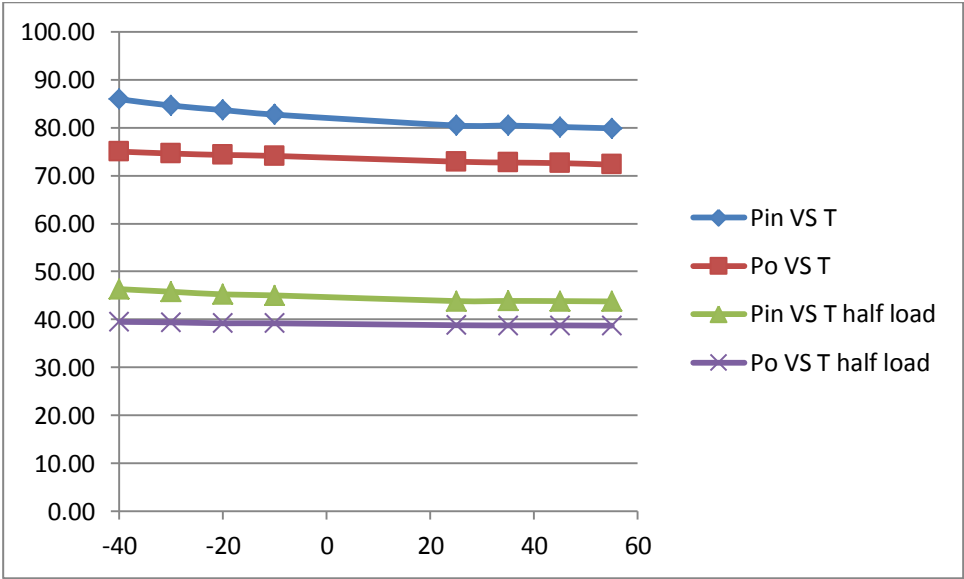

Io vs. Ambient temperature

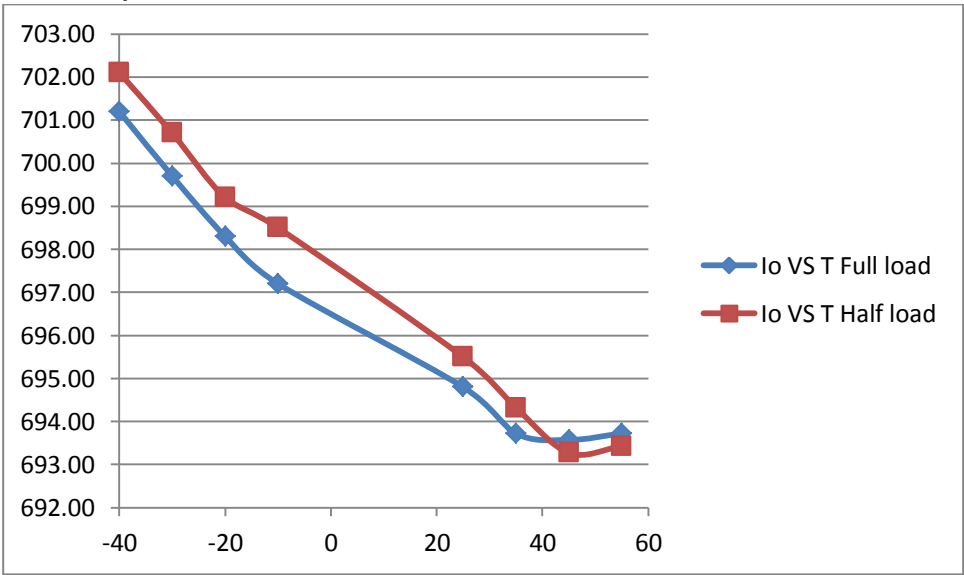

Revised 03/15/2013



9290 008 65208	
Brand Name	XITANIUM
Description	Xitanium 75W 0.70A 230V-Y cXt
Input Voltage	220~240V
Input Frequency	50/60Hz
RoHS	Yes
Status	Released

Electrical Specifications

THD vs. Ambient temperature

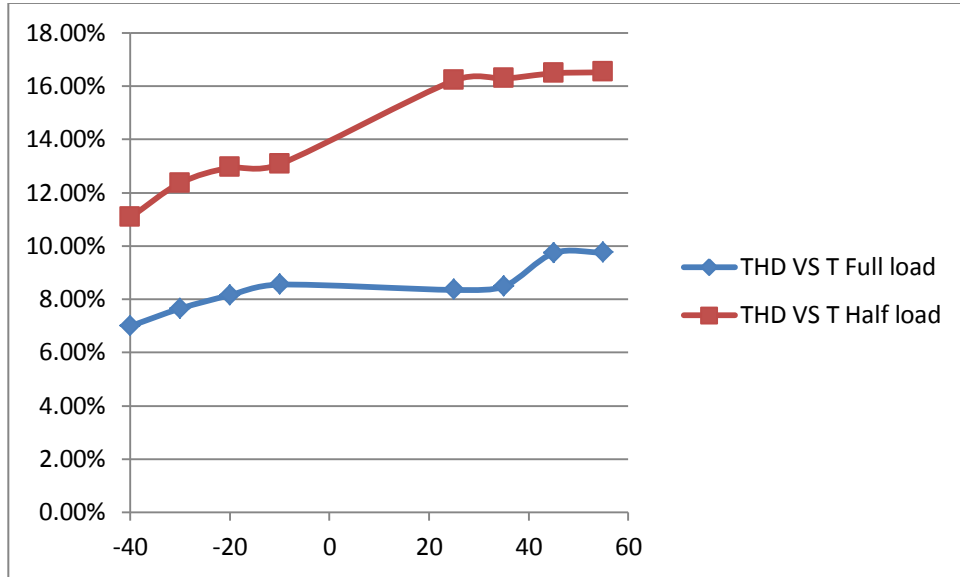

Effi vs. Ambient temperature

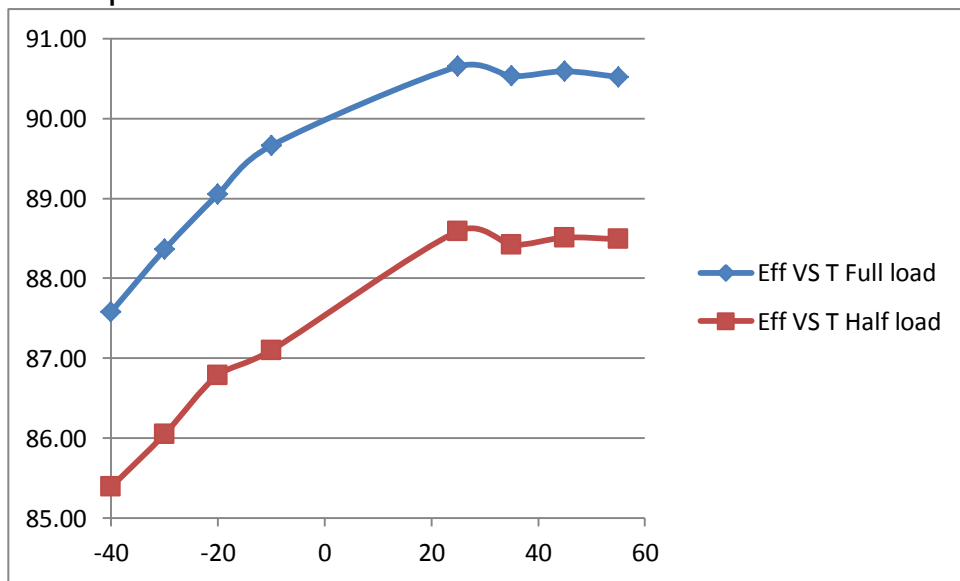

Revised 03/15/2013

9290 008 65208

Brand Name	XITANIUM
Description	Xitanium 75W 0.70A 230V-Y cXt
Input Voltage	220~240V
Input Frequency	50/60Hz
RoHS	Yes
Status	Released

Electrical Specifications

lout vs. Tcase of Driver:

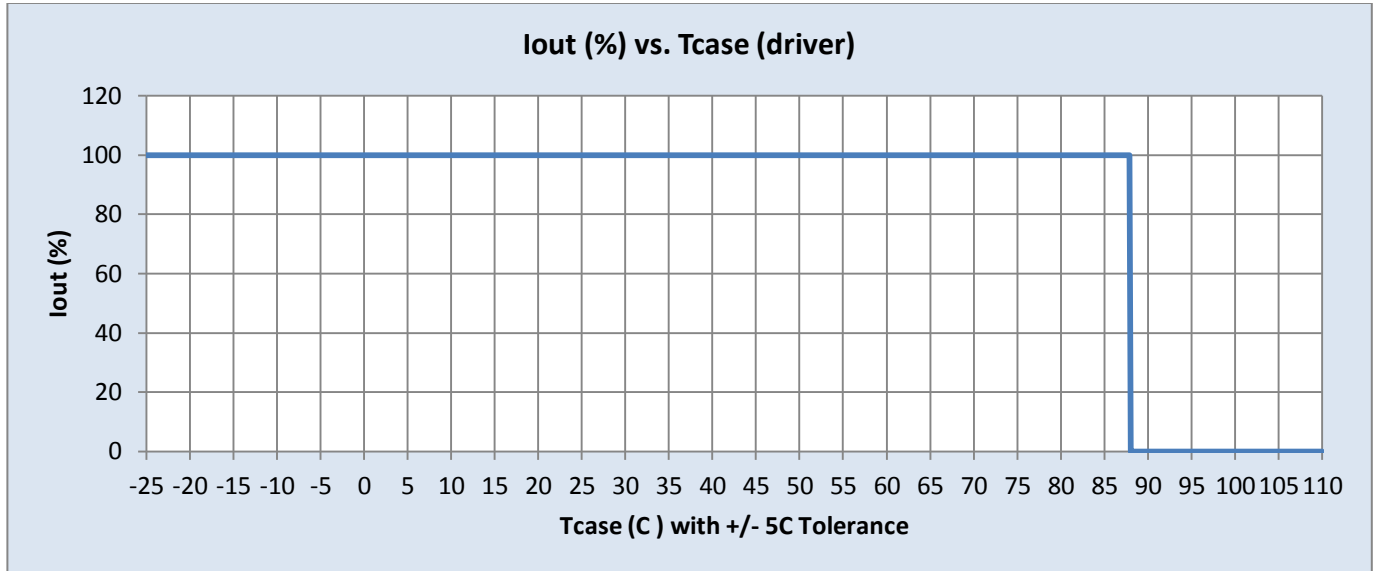

Inrush Current Info:

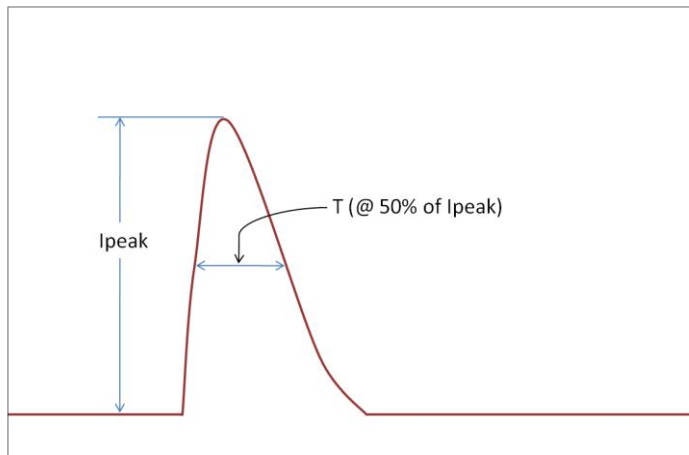

Vin	Ipeak	T (@ 50% of Ipeak)
220 Vrms	32A	389 μ s
230 Vrms	33.9 A	380 μ s
240 Vrms	35.7 A	374 μ s

Revised 03/15/2013



9290 008 65208

Brand Name	XITANIUM
Description	Xitanium 75W 0.70A 230V-Y cXt
Input Voltage	220~240V
Input Frequency	50/60Hz
RoHS	Yes
Status	Released

Electrical Specifications

Lifetime vs. Tcase of Driver:

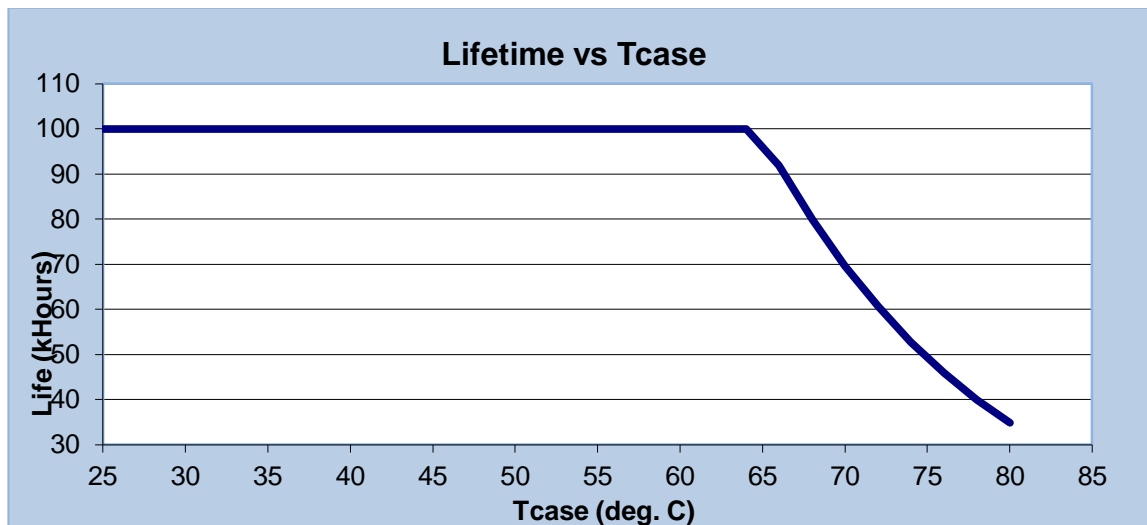

Failure Rate Info: <0.01% per 1 kHr @<= Tcase 70 C

Isolation:

Isolation	Input Wires	Output Wires	Chassis
Input Wires	NA	1480 Vac	1480 Vac
Output Wires	1480 Vac	NA	1480 Vac
Chassis	1480 Vac	1480 Vac	NA

Revised 03/15/2013

9290 008 65208

Brand Name	XITANIUM
Description	Xitanium 75W 0.70A 230V-Y cXt
Input Voltage	220~240V
Input Frequency	50/60Hz
RoHS	Yes
Status	Released

Electrical Specifications

Mechanical drawing:

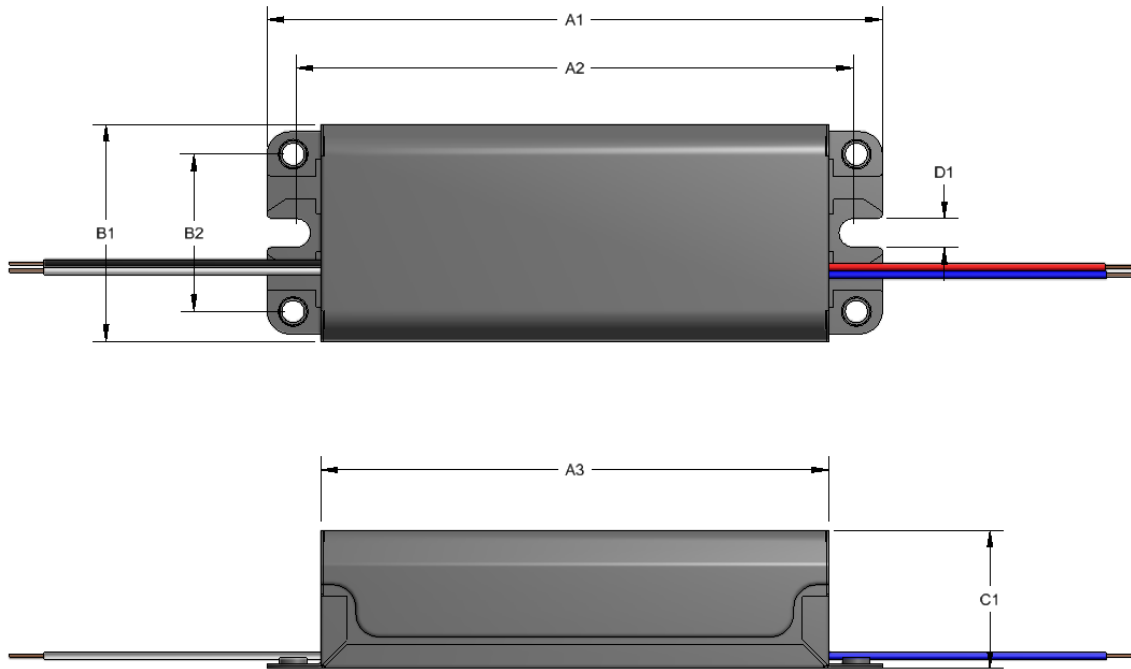

A1	A2	A3	B1	B2	C1	D1
168mm	152mm	139mm	60mm	43mm	39mm	8mm

Revised 03/15/2013