



### Driver LC 20W 350/500/700mA flexC SR ADV

ADVANCED series

#### Product description

- Independent constant current LED Driver
- Selectable output current between 350, 500 and 700 mA
- Max. output power 20 W
- Up to 85 % efficiency
- Nominal life-time up to 50,000 h
- For luminaires of protection class I and protection class II
- For luminaires with M and MM as per EN 60598, VDE 0710 and VDE 0711
- Temperature protection as per EN 61347-2-13 C5e
- 5-year guarantee



#### Housing properties

- Casing: polycarbonate, white
- Type of protection IP20

#### Interfaces

- Terminal blocks: 0° screw terminals

#### Functions

- Overload protection
- Short-circuit protection
- No-load protection
- Overtemperature protection
- Burst protection voltage 1 kV
- Surge protection voltage 1 kV (L to N)
- Surge protection voltage 2 kV (L/N to earth)

#### Typical applications

- For spot light and downlight in retail and hospitality application
- For panel light and area light in office and education application



**Standards**, page 3

**Wiring diagrams and installation examples**, page 3

IP20 SELV 

RoHS 

### Driver LC 20W 350/500/700mA flexC SR ADV

ADVANCED series

#### Technical data

Rated supply voltage	220 – 240 V
AC voltage range	198 – 264 V
Max. input current (at 230 V, 50 Hz, full load)	0.12 A
Leakage current (at 230 V, 50 Hz, full load)	< 450 µA
Mains frequency	50 / 60 Hz
Overvoltage protection	320 V AC, 1 h
Max. input power	26 W
Typ. power consumption (at 230 V, 50 Hz, full load) <sup>①</sup>	24 W
Min. output power	8.7 W
Max. output power	20 W
Typ. efficiency (at 230 V / 50 Hz / full load) <sup>②</sup>	85 %
λ (at 230 V, 50 Hz, full load) <sup>③</sup>	0.95
Output current tolerance <sup>④</sup>	± 10 %
Max. output current peak <sup>⑤</sup>	≤ output current + 20 %
Max. output voltage	60 V
THD (at 230 V, 50 Hz, full load)	< 20 %
Output LF current ripple (< 120 Hz)	± 5 %
Time to light (at 230 V, 50 Hz, full load)	≤ 1.2 s
Turn off time (at 230 V, 50 Hz, full load)	≤ 0.2 s
Hold on time at power failure (output)	0 s
Ambient temperature ta (at life-time 50,000 h)	40 °C
Storage temperature ts	-40 ... +80 °C
Dimensions L x W x H	101.5 x 51 x 29.5 mm

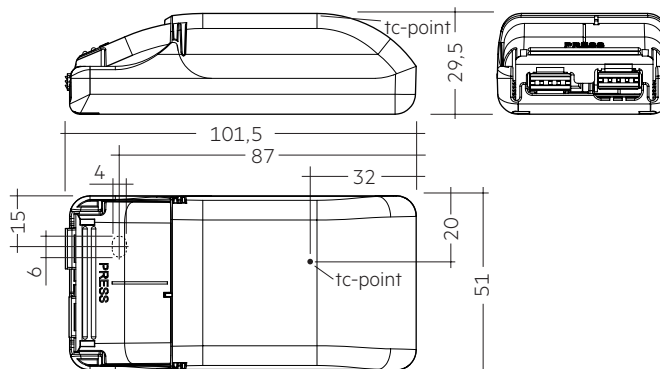

#### Ordering data

Type	Article number	Packaging, carton	Packaging, low volume	Packaging, high volume	Weight per pc.
LC 20W 350/500/700mA flexC SR ADV	87500621	20 pc(s).	280 pc(s).	3,360 pc(s).	0.094 kg

#### Specific technical data

Type	Output current <sup>②</sup>	Min. forward voltage	Max. forward voltage	Max. output power	Typ. power consumption (at 230 V, 50 Hz, full load)	Typ. current consumption (at 230 V, 50 Hz, full load)	Efficiency (at 230 V, 50 Hz, full load)	Efficiency (at 230 V, 50 Hz, min. load)	Max. casing temperature tc	Ambient temperature ta max.
LC 20W 350/500/700mA flexC SR ADV	350 mA	25 V	50.0 V	17.5 W	21 W	100 mA	85.0 %	78 %	80 °C	-20 ... +50 °C
	500 mA	20 V	40.0 V	20.0 W	24 W	110 mA	83.5 %	78 %	85 °C	-20 ... +50 °C
	700 mA	14 V	28.5 V	20.0 W	24 W	110 mA	82.0 %	75 %	85 °C	-20 ... +50 °C

<sup>①</sup> Test result at 700 mA.

<sup>②</sup> Output current is mean value.

<sup>③</sup> Test result at 25 °C.

## 1. Standards

EN 55015  
EN 60598-1  
EN 61000-3-2  
EN 61000-3-3  
EN 61347-1  
EN 61347-2-13  
EN 61547  
EN 62384

### 1.1 Glow wire test

according to EN 61347-1 with increased temperature of 850 °C passed.

## 2. Thermal details and life-time

### 2.1 Expected life-time

Expected life-time				
Type	Current	ta	40 °C	50 °C
LC 20W 350/500/700mA flexC SR ADV	350 mA	tc	70 °C	80 °C
		Life-time	50,000h	30,000h
	500 mA	tc	75 °C	85 °C
		Life-time	50,000h	30,000h
	700 mA	tc	75 °C	85 °C
		Life-time	50,000h	30,000h

The LED Driver is designed for a life-time stated above under reference conditions and with a failure probability of less than 10 %.

## 3. Installation / wiring

### 3.1 Circuit diagram

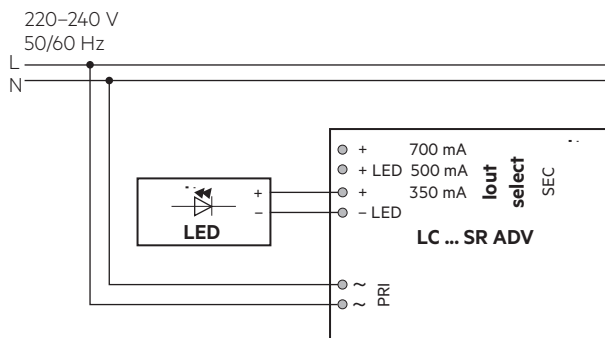

### 3.2 Wiring type and cross section

The wiring can be in stranded wires with ferrules or solid. For perfect function of the cage clamp terminals the strip length should be 4 – 5 mm for the input terminal.

The max. torque at the clamping screw (M3) is 0.2 Nm.

#### Input terminal (D2)

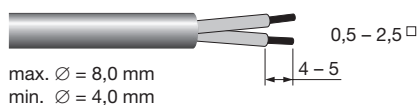

#### Output terminal (D1)

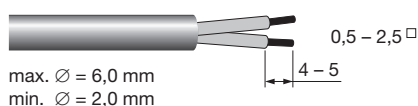

To get a proper working strain relief it is recommended that the cable jacket diameter of the side D2 is 2 mm bigger than the diameter of the side D1. (This can vary if the used cable jacket material varies from side D2 to D1 in pinching property).

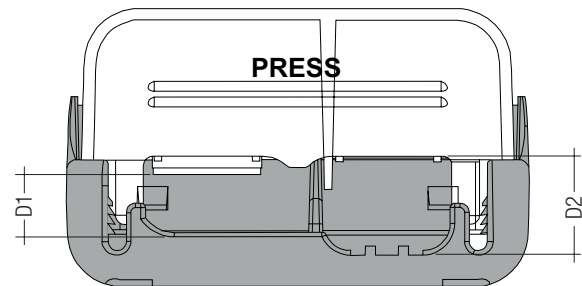

Depending on the used flaps of the terminal following cable jacket diameter difference between the side D2 and D1 terminals is recommended:

Side D1		Side D2		Difference D2 - D1
Housing bottom	Cover terminal	With flap	Without flap	
With flap	Without flap	With flap	Without flap	
x	-	x	-	3.5 mm
x	-	x	-	5.5 mm
x	-	-	x	3.5 mm
-	x	x	-	3.5 mm
-	x	-	x	1.5 mm
x	-	-	x	1.5 mm
-	x	x	-	1.5 mm
-	x	-	x	-0.5 mm

### 3.3 Fixing conditions

Dry, acidfree, oilfree, fatfree. It is not allowed to exceed the maximum ambient temperature (ta) stated on the device. Minimum distances stated below are recommendations and depend on the actual luminaire. Is not suitable for fixing in corner.

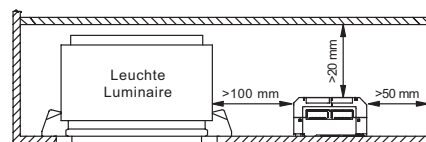

The LED module and all contact points within the wiring must be sufficiently insulated against 3 kV surge voltage.

### 3.4 Wiring guidelines

- All connections must be kept as short as possible to ensure good EMI behaviour.
- Mains leads should be kept apart from LED Driver and other leads (ideally 5 – 10 cm distance)
- Max. length of output wires is 2 m.
- Incorrect wiring can damage LED modules.
- To avoid the damage of the Driver, the wiring must be protected against short circuits to earth (sharp edged metal parts, metal cable clips, louver, etc.).
- The current selection has to be installed in the accordance to the requirement of low voltage installation.

### 3.5 Replace LED module

1. Mains off
2. Remove LED module
3. Wait for 20 seconds
4. Connect LED module again

Hot plug-in or output switching of LEDs is not permitted and may cause a very high current to the LEDs.

### 3.6 Current select

For 350 mA current use this terminals:

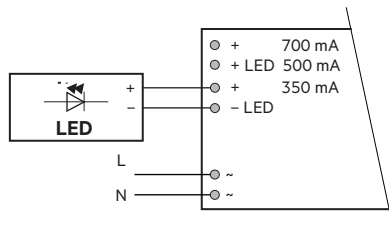

For 500 mA current use this terminals:

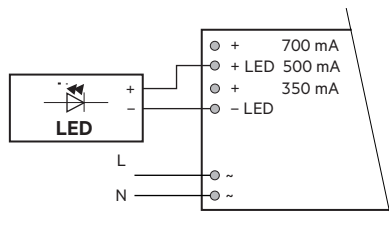

For 700 mA current use this terminals:

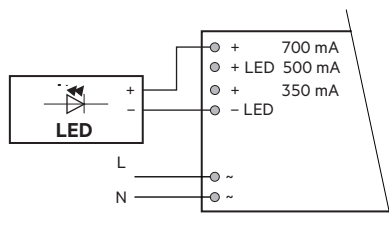

### 3.7 Mounting of device

Max. torque for fixing: 0.5 Nm/M4

## 4. Electrical values

Test at 230 V 50 Hz.

### 4.1 Efficiency vs load

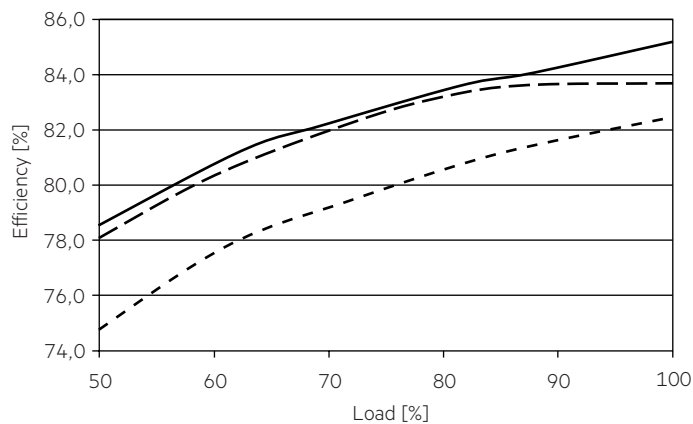

### 4.2 Power factor vs load

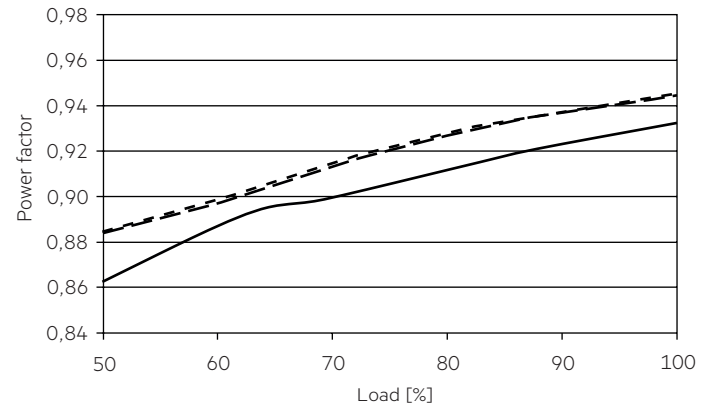

### 4.3 Input power vs load

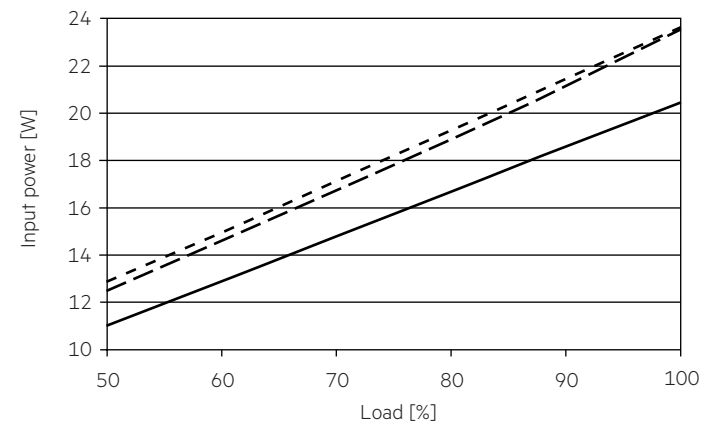

### 4.4 Input current vs load

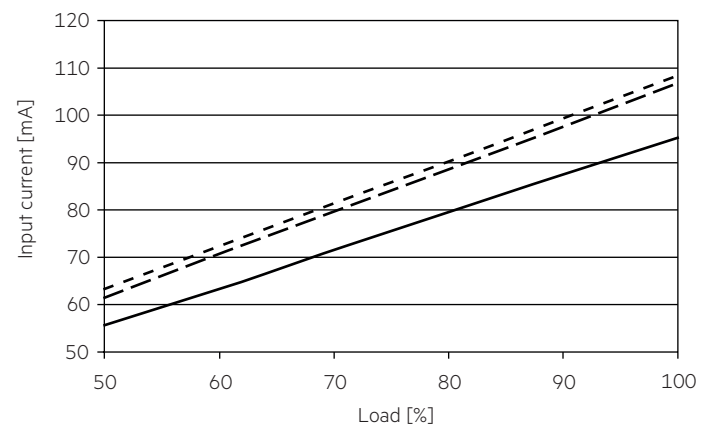

#### 4.5 THD vs load

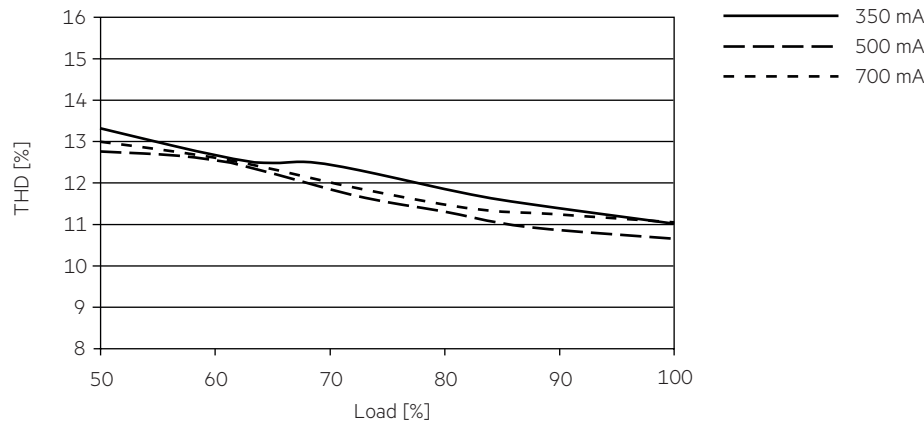

#### 4.6 Maximum loading of automatic circuit breakers

Automatic circuit breaker type	C10	C13	C16	C20	B10	B13	B16	B20	Inrush current
Installation Ø	1.5 mm <sup>2</sup>	1.5 mm <sup>2</sup>	1.5 mm <sup>2</sup>	2.5 mm <sup>2</sup>	1.5 mm <sup>2</sup>	1.5 mm <sup>2</sup>	1.5 mm <sup>2</sup>	2.5 mm <sup>2</sup>	I <sub>max</sub> Time
<b>LC 20W 350/500/700mA flexC SR ADV</b>	65	84	104	130	65	84	104	130	10 A 80 µs

#### 4.7 Harmonic distortion in the mains supply (at 230 V / 50 Hz and full load) in %

	THD	3.	5.	7.	9.	11.
<b>LC 20W 350/500/700mA flexC SR ADV</b>	< 20	< 11	< 5	< 5	< 4	< 3

## 5. Functions

### 5.1 Short-circuit behaviour

In case of a short circuit on the output side (LED) the LED Driver protects itself. After elimination of the short-circuit fault the LED Driver will recover automatically.

### 5.2 No-load operation

In no-load operation the output voltage will not exceed the specified max. output voltage.

### 5.3 Overload protection

If the output voltage range is exceeded the LED Driver will protect itself and LED may flicker. After elimination of the overload, the nominal operation is restored automatically.

### 5.4 Over temperature protection

The LED Driver is protected against temporary thermal overheating. If the temperature limit is exceeded the output current is reduced to limit it to a certain level.

## 6. Miscellaneous

### 6.1 Isolation and electric strength testing of luminaires

Electronic devices can be damaged by high voltage. This has to be considered during the routine testing of the luminaires in production.

According to IEC 60598-1 Annex Q (informative only!) or ENEC 303-Annex A, each luminaire should be submitted to an isolation test with 500 V<sub>DC</sub> for 1 second. This test voltage should be connected between the interconnected phase and neutral terminals and the earth terminal. The isolation resistance must be at least 2 MΩ.

As an alternative, IEC 60598-1 Annex Q describes a test of the electrical strength with 1500 V<sub>AC</sub> (or 1.414 x 1500 V<sub>DC</sub>). To avoid damage to the electronic devices this test must not be conducted.

### 6.2 Conditions of use and storage

Humidity: 5% up to max. 85%, not condensed (max. 56 days/year at 85%)

Storage temperature: -40 °C up to max. +80 °C

The devices have to be within the specified temperature range (t<sub>a</sub>) before they can be operated.

### 6.3 Additional information

Additional technical information at [www.tridonic.com](http://www.tridonic.com) → Technical Data

Guarantee conditions at [www.tridonic.com](http://www.tridonic.com) → Services

Life-time declarations are informative and represent no warranty claim. No warranty if device was opened.