

**Driver LC 40W 800-1050mA flexC SC ADV**  
ADVANCED series

**Product description**

- Can be either used build-in or independent with clip-on strain-relief (see accessory)
- Constant current LED Driver
- Adjustable output current between 800 and 1,050 mA, in 5 steps with ADV plug technology (pre-selected current 800 mA)
- Max. output power 44.1 W
- For luminaires of protection class I and protection class II
- Temperature protection as per EN 61347-2-13 C5e
- Small design (97 x 43 x 30 mm)
- Nominal life-time up to 50,000 h
- 5-year guarantee

**Properties**

- Casing: polycarbonat, white
- Type of protection IP20

**Functions**

- Overtemperature protection
- Overload protection
- Short-circuit protection
- No-load protection
- Burst protection voltage 1 kV
- Surge protection voltage 1 kV (L to N)
- Surge protection voltage 2 kV (L/N to earth)

**Typical applications**

- For spot light and downlight in retail and hospitality application
- For panel light and area light in office and education application



**Standards**, page 5

**Wiring diagrams and installation examples**, page 5

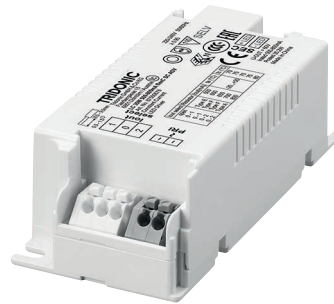

With strain-relief (see accessory)

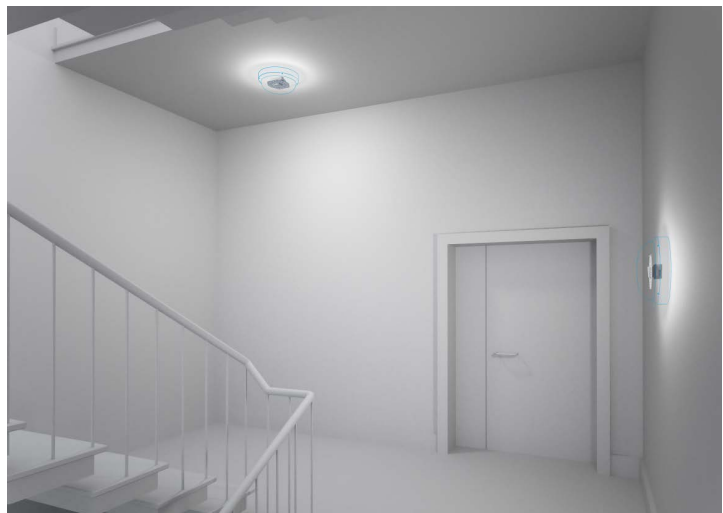

IP20 SELV 

### Driver LC 40W 800-1050mA flexC SC ADV

ADVANCED series

#### Technical data

Rated supply voltage	220 – 240 V
AC voltage range	198 – 264 V
Max. input current (at 230 V, 50 Hz, full load)	0.22 A
Leakage current (at 230 V, 50 Hz, full load)	< 450 µA
Mains frequency	50 / 60 Hz
Overvoltage protection	320 V AC, 1 h
Max. input power	54 W
Typ. power consumption (at 230 V, 50 Hz, full load) <sup>①</sup>	49.3 W
Min. output power	20 W
Max. output power	44.1 W
Typ. efficiency (at 230 V / 50 Hz / full load) <sup>②</sup>	88 %
λ (at 230 V, 50 Hz, full load) <sup>③</sup>	0.95
Output current tolerance <sup>④</sup>	± 7.5 %
Max. output current peak <sup>⑤</sup>	≤ output current + 12.5 %
Max. output voltage	60 V
THD (at 230 V, 50 Hz, full load) <sup>⑥</sup>	< 10 %
Output LF current ripple (< 120 Hz)	± 5 %
Time to light (at 230 V, 50 Hz, full load)	< 0.5 s
Turn off time (at 230 V, 50 Hz, full load)	≤ 0.5 s
Hold on time at power failure (output)	0 s
Ambient temperature <i>t</i> <sub>a</sub> (at life-time 50,000 h)	40 °C
Storage temperature <i>t</i> <sub>s</sub>	-40 ... +80 °C
Dimensions L x W x H	97 x 43 x 30 mm

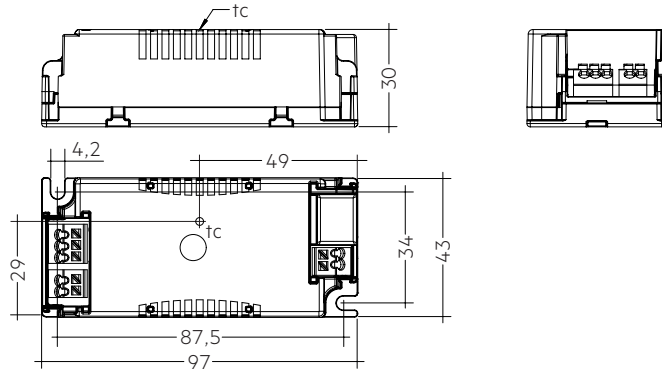

#### Ordering data

Type	Article number	Packaging, carton	Packaging, low volume	Packaging, high volume	Weight per pc.
LC 40W 800-1050mA flexC SC ADV	87500679	15 pc(s).	480 pc(s).	3,840 pc(s).	0.105 kg

#### Specific technical data

Type	Output current <sup>②</sup>	Min. forward voltage	Max. forward voltage	Max. output power	Typ. power consumption (at 230 V, 50 Hz, full load)	Typ. current consumption (at 230 V, 50 Hz, full load)	Max. casing temperature <i>t</i> <sub>c</sub>	Ambient temperature <i>t</i> <sub>a</sub> max.	Output select	Resistor <sup>④</sup>
LC 40W 800-1050mA flexC SC ADV	800 mA	25 V	40 V	32.0 W	36.0 W	163 mA	70 °C	-20 ... +50 °C	open	-
	850 mA	25 V	41 V	34.9 W	39.0 W	177 mA	70 °C	-20 ... +50 °C	0-1	ADV Type E
	900 mA	25 V	42 V	37.8 W	42.7 W	190 mA	75 °C	-20 ... +50 °C	0-1	ADV Type A
	950 mA	25 V	42 V	39.9 W	44.9 W	200 mA	75 °C	-20 ... +50 °C	0-2	ADV Type F
	1,050 mA	30 V	42 V	44.1 W	49.3 W	220 mA	80 °C	-20 ... +50 °C	0-2	ADV Type A

<sup>①</sup> Test result at 1,050 mA.

<sup>②</sup> Output current is mean value.

<sup>③</sup> Test result at 25 °C.

<sup>④</sup> Type A is a short circuit plug (0 Ω).



**Strain-relief set 43x30mm**

**Product description**

- Optional strain-relief set for independent applications
- Transforms the LED Driver into a fully class II compatible LED Driver (e.g. ceiling installation)
- Easy and tool-free mounting to the LED Driver, screwless cable-clamp channels for long strain-relief (30 x 43 x 30 mm)
- With screws for short strain-relief (15 x 34 x 30 mm)
- Overall length = length L (LED Driver) + 2 x 30 mm (long strain-relief set), 2 x 15 mm (short strain-relief) or long and short strain-relief any combination
- Standard SC (L = 30 mm) available as non-pre-assembled and pre-assembled
- Short SC (L = 15 mm) only pre-assembled available



ACU SC 30x43x30mm CLIP-ON SR SET      ACU SC 30x43x30mm CLIP-ON SR SET 300  
(28001168, non-pre-assembled)      (28001351, non-pre-assembled, 300 pcs. packaging)



ACU SC 30x43x30mm CLIP-ON SR PA  
(28001699, pre-assembled)

ACU SC 15x43x30mm CLIP-ON SR PA  
(28001574, pre-assembled)

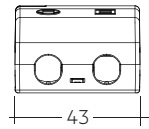
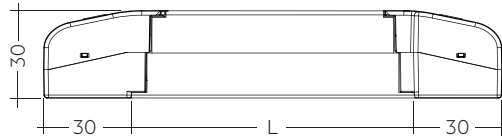

Permissible  
cable jacket  
diameter:  
2.2 – 9 mm

ACU SC 30x43x30mm CLIP-ON SR SET / PA

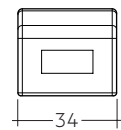
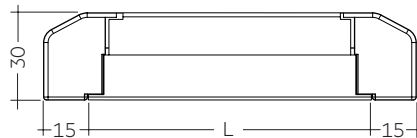

Permissible  
cable jacket  
diameter:  
3 – 9 mm

ACU SC 15x43x30mm CLIP-ON SR PA

**Ordering data**

Type	Article number	Packaging carton <sup>®</sup>	Packaging outer box	Weight per pc.
<b>ACU SC 43x30mm CLIP-ON SR SET</b>	<b>28001168</b>	10 pc(s).	500 pc(s).	0.021 kg
<b>ACU SC 43x30mm CLIP-ON SR SET 300</b>	<b>28001351</b>	300 pc(s).	300 pc(s).	0.021 kg
<b>ACU SC 30x43x30mm CLIP-ON SR PA</b>	<b>28001699</b>	10 pc(s).	500 pc(s).	0.021 kg
<b>ACU SC 15x43x30mm CLIP-ON SR PA</b>	<b>28001574</b>	10 pc(s).	1,200 pc(s).	0.010 kg

<sup>®</sup> 28001168: A carton of 10 pcs. is equal to 10 sets, each with 2 strain-reliefs parts.

28001351: A carton of 300 pcs. is equal to 300 sets, each with 2 strain-reliefs parts.

28001699 + 28001574: A carton contains exactly 10 pcs. strain-reliefs (no sets).

**Product description**

- Ready-for-use resistor to set output current value
- Compatible with LED Driver serie LC flexC ADV; not compatible with I-select (generation 1) and I-select 2 (generation 2)
- Resistor is base isolated
- When using your own resistors, make sure the resistor must be isolated
- Resistor power 0.25 W
- Current tolerance  $\pm 2\%$  additional to output current tolerance
- Hot plug of the resistor is not permitted
- For detailed current setting see table "Specific technical data" of the respective LED Driver and chapter 3.8 Current setting

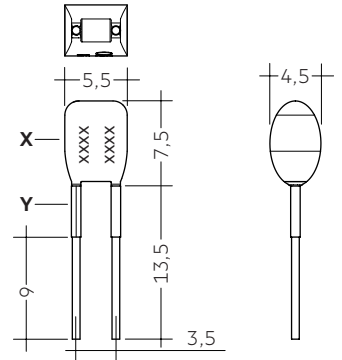

**Ordering data**

Type	Article number	Colour of X area	Colour of Y area	Marking	Resistor value	Packaging bag	Weight per pc.
<b>ADV Plug Type A YL</b>	<b>28001771</b>	Yellow	Yellow	A	0 $\Omega$	10 pc(s).	0.001 kg
<b>ADV Plug Type E YL</b>	<b>28002096</b>	Yellow	Brown	E	100 $\Omega$	10 pc(s).	0.001 kg
<b>ADV Plug Type F YL</b>	<b>28002097</b>	Yellow	Grey	F	30 $\Omega$	10 pc(s).	0.001 kg

## 1. Standards

EN 55015  
EN 61000-3-2  
EN 61000-3-3  
EN 61347-1  
EN 61347-2-13  
EN 61547  
EN 62384

### 1.1 Glow-wire test

according to EN 61347-1 with increased temperature of 850 °C passed.

## 2. Thermal details and life-time

### 2.1 Expected life-time

Expected life-time				
Type	Output current	ta	40 °C	50 °C
	800 mA	tc	60 °C <sup>Ⓟ</sup>	70 °C <sup>Ⓟ</sup>
		Life-time	50,000 h	30,000 h
	850 mA	tc	60 °C <sup>Ⓟ</sup>	70 °C <sup>Ⓟ</sup>
		Life-time	50,000 h	30,000 h
LC 40W 800-1050mA flexC SC ADV	900 mA	tc	65 °C <sup>Ⓟ</sup>	75 °C <sup>Ⓟ</sup>
		Life-time	50,000 h	30,000 h
	950 mA	tc	65 °C <sup>Ⓟ</sup>	75 °C <sup>Ⓟ</sup>
		Life-time	50,000 h	30,000 h
1,050 mA	tc	70 °C <sup>Ⓟ</sup>	80 °C <sup>Ⓟ</sup>	
	Life-time	50,000 h	30,000 h	

<sup>Ⓟ</sup> Test result at max. output voltage.

The LED Drivers are designed for a life-time stated above under reference conditions and with a failure probability of less than 10 %.

## 3. Installation / wiring

### 3.1 Circuit diagram

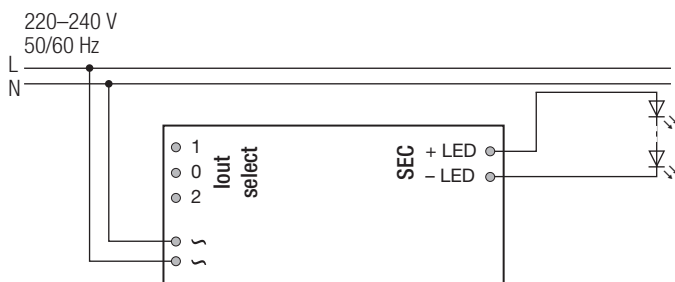

### 3.2 Wiring type and cross section

The wiring can be in stranded wires with ferrules or solid with a cross section of 0.5–1.5 mm<sup>2</sup>. Strip 8.5–9.5 mm of insulation from the cables to ensure perfect operation of the push-wire terminals. Use one wire for each terminal connector only.

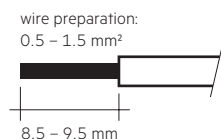

### 3.3 Release of the wiring

Press down the “push button” and remove the cable from front.

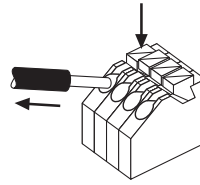

### 3.4 Fixing conditions when using as independent Driver with Clip-On

Dry, acidfree, oilfree, fatfree. It is not allowed to exceed the maximum ambient temperature (ta) stated on the device. Minimum distances stated below are recommendations and depend on the actual luminaire. Is not suitable for fixing in corner.

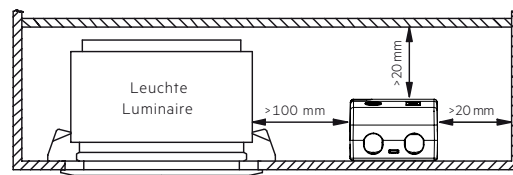

### 3.5 Wiring guidelines

- All connections must be kept as short as possible to ensure good EMI behaviour.
- Mains leads should be kept apart from LED Driver and other leads (ideally 5 – 10 cm distance)
- Max. length of output wires is 2 m.
- Secondary switching is not permitted.
- Incorrect wiring can damage LED modules.
- The wiring must be protected against short circuits to earth (sharp edged metal parts, metal cable clips, louver, etc.).

### 3.6 Replace LED module

1. Mains off
2. Remove LED module
3. Wait for 20 seconds
4. Connect LED module again

Hot plug-in or secondary switching of LEDs is not permitted and may cause a very high current to the LEDs.

### 3.7 Installation instructions

The LED module and all contact points within the wiring must be sufficiently insulated against 3 kV surge voltage. Air and creepage distance must be maintained.

### 3.8 Current setting

**800 mA:** All terminals open

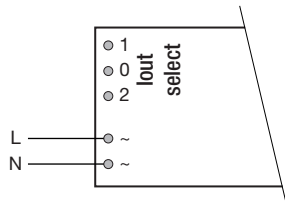

**850 mA:** Terminal 0 and 1 connected with resistor ADV Plug Type E BR (article number: 28002096)

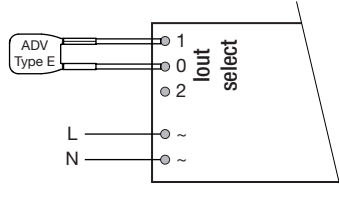

**900 mA:** Terminal 0 and 1 connected with 0 Ω wire (max. 6 cm length) or resistor ADV Plug Type A BR (article number: 28001771)

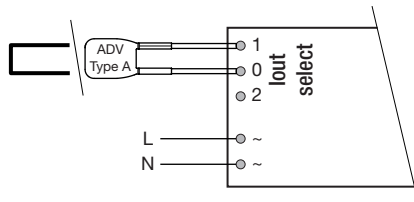

**950 mA:** Terminal 0 and 2 connected with resistor ADV Plug Type F BR (article number: 28002097)

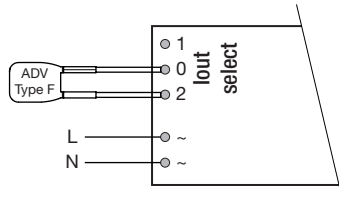

**1,050 mA:** Terminal 0 and 2 connected with 0 Ω wire (max. 6 cm length) or resistor ADV Plug Type A BR (article number: 28001771)

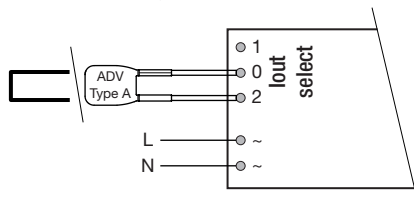

### 3.9 Mounting of device

Max. torque for fixing: 0.5 Nm/M4

## 4. Electrical values

### 4.1 Efficiency vs load

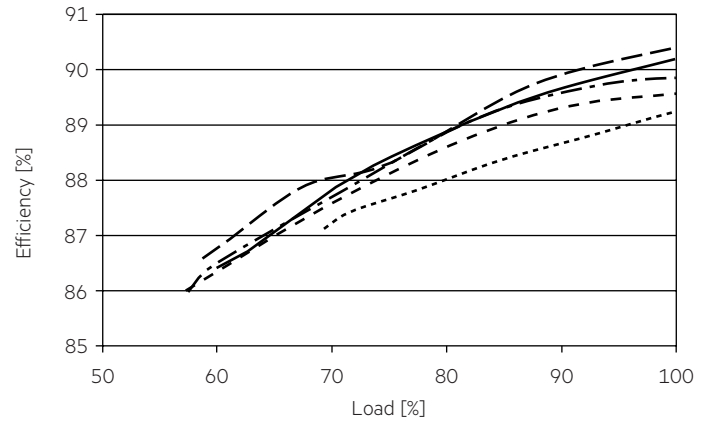

### 4.2 Power factor vs load

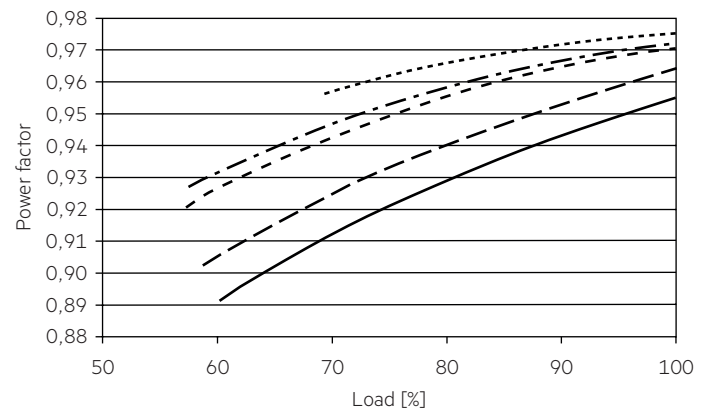

### 4.3 Input power vs load

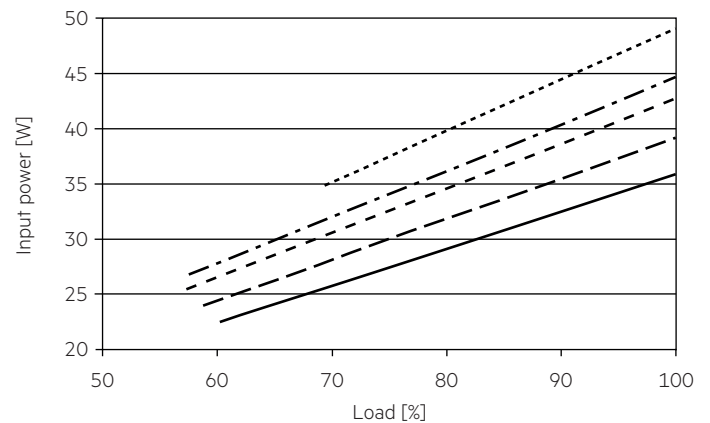

#### 4.4 Input current vs load

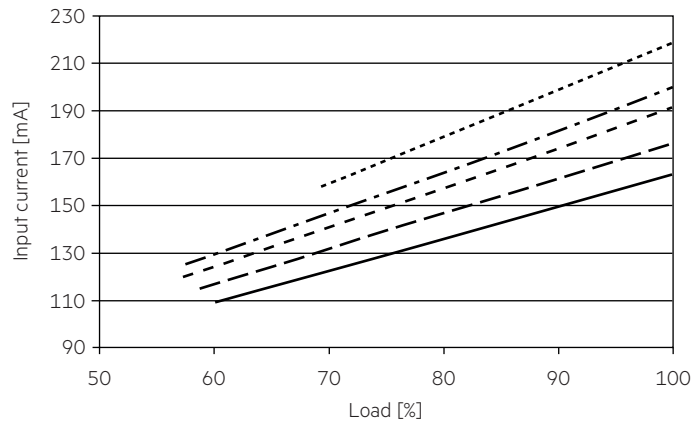

#### 4.5 THD vs load

THD without harmonic < 5 mA (0.6 %) of the input current:

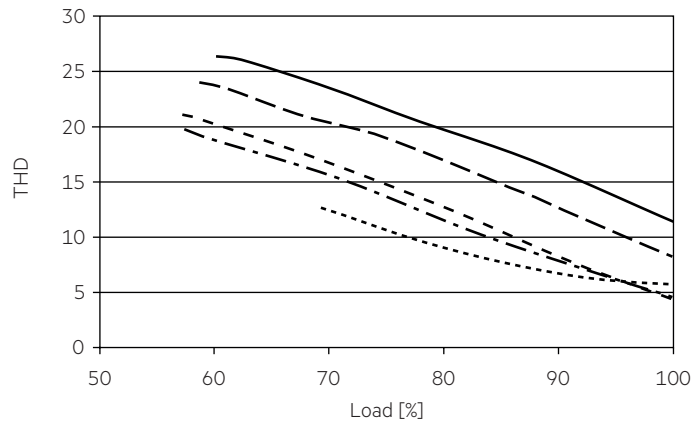

- 800 mA
- - - 850 mA
- - - - 900 mA
- · - · - 950 mA
- · · · · 1050 mA

#### 4.3 Maximum loading of automatic circuit breakers

Automatic circuit breaker type	C10	C13	C16	C20	B10	B13	B16	B20	Inrush current	
Installation Ø	1.5 mm <sup>2</sup>	1.5 mm <sup>2</sup>	1.5 mm <sup>2</sup>	2.5 mm <sup>2</sup>	1.5 mm <sup>2</sup>	1.5 mm <sup>2</sup>	1.5 mm <sup>2</sup>	2.5 mm <sup>2</sup>	<i>I</i> <sub>max</sub>	Time
<b>LC 40W 800-1050mA flexC SC ADV</b>	16	24	32	38	8	12	16	20	25 A	250 µs

#### 4.4 Harmonic distortion in the mains supply (at 230 V / 50 Hz and full load) in %

	THD	3.	5.	7.	9.	11.
<b>LC 40W 800-1050mA flexC SC ADV</b>	< 10	< 5	< 5	< 5	< 5	< 3

Acc. to 6100-3-2. Harmonics < 5 mA or < 0.6 % (whatever is greater) of the input current are not considered for calculation of THD.

## 5. Functions

### 5.1 Short-circuit behaviour

In case of a short circuit on the secondary side (LED) the LED Driver switches off. After elimination of the short-circuit fault the LED Driver will recover automatically.

### 5.2 No-load operation

The LED Driver works in burst working mode to provide a constant output voltage regulation which allows the application to be able to work safely when LED string opens due to a failure.

### 5.3 Overload protection

If the output voltage range is exceeded, the LED Driver will protect itself and LED may flicker. After elimination of the overload the nominal operation will recover automatically.

### 5.4 Overtemperature protection

The LED Driver is protected against temporary thermal overheating. If the temperature limit is exceeded the LED-Driver will switch off. It restarts automatically.

## 6. Miscellaneous

### 6.1 Isolation and electric strength testing of luminaires

Electronic devices can be damaged by high voltage. This has to be considered during the routine testing of the luminaires in production.

According to IEC 60598-1 Annex Q (informative only!) or ENEC 303-Annex A, each luminaire should be submitted to an isolation test with 500 V<sub>DC</sub> for 1 second. This test voltage should be connected between the interconnected phase and neutral terminals and the earth terminal. The isolation resistance must be at least 2 MΩ.

As an alternative, IEC 60598-1 Annex Q describes a test of the electrical strength with 1500 V<sub>AC</sub> (or 1.414 x 1500 V<sub>DC</sub>). To avoid damage to the electronic devices this test must not be conducted.

### 6.2 Conditions of use and storage

Humidity: 5% up to max. 85%,  
not condensed  
(max. 56 days/year at 85%)

Storage temperature: -40 °C up to max. +80 °C

The devices have to be within the specified temperature range (ta) before they can be operated.

### 6.3 Additional information

Additional technical information at [www.tridonic.com](http://www.tridonic.com) → Technical Data

Guarantee conditions at [www.tridonic.com](http://www.tridonic.com) → Services

Life-time declarations are informative and represent no warranty claim. No warranty if device was opened.