

Driver LC 50W 900-1200mA flexC SC ADV

advanced series

Product description

- Can be either used build-in or independent with clip-on strain-relief (see accessory)
- Constant current LED Driver
- Adjustable output current between 900 and 1,200 mA, in 5 steps with ADV plug technology (pre-selected current 900 mA)
- Max. output power 51.6 W
- For luminaires of protection class I and protection class II
- Temperature protection as per EN 61347-2-13 C5e
- Small design (115 x 43 x 30 mm)
- Nominal life-time up to 100,000 h
- 5-year guarantee

Properties

- Casing: polycarbonat, white
- Type of protection IP20

Functions

- Overtemperature protection
- Overload protection
- Short-circuit protection
- No-load protection
- Burst protection voltage 1 kV
- Surge protection voltage 1 kV (L to N)
- Surge protection voltage 2 kV (L/N to earth)

Typical applications

- For spot light and downlight in retail and hospitality application
- For panel light and area light in office and education application



Standards, page 5

Wiring diagrams and installation examples, page 5



With strain-relief (see accessory)

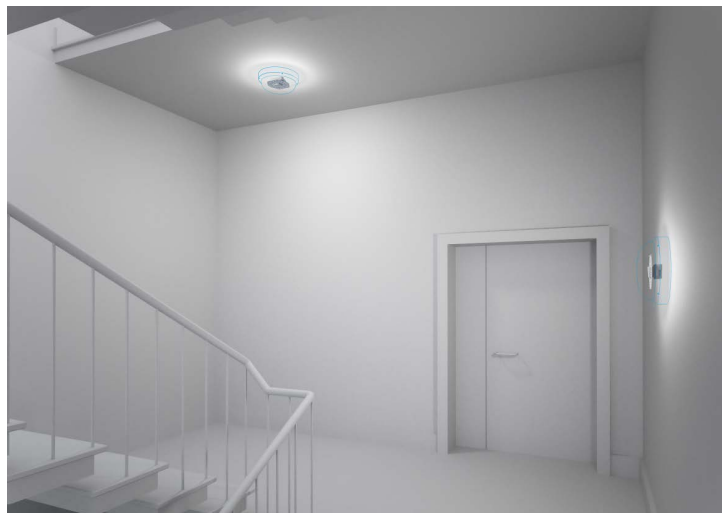

IP20 SELV 

Driver LC 50W 900-1200mA flexC SC ADV

advanced series

Technical data

| | |
|--|---------------------------|
| Rated supply voltage | 220 – 240 V |
| AC voltage range | 198 – 264 V |
| Max. input current (at 230 V, 50 Hz, full load) | 0.26 A |
| Leakage current (at 230 V, 50 Hz, full load) | < 450 µA |
| Mains frequency | 50 / 60 Hz |
| Overvoltage protection | 320 V AC, 1 h |
| Max. input power | 58 W |
| Typ. power consumption (at 230 V, 50 Hz, full load) ^① | 56.5 W |
| Min. output power | 24.3 W |
| Max. output power | 51.6 W |
| Typ. efficiency (at 230 V / 50 Hz / full load) ^② | 90 % |
| λ (at 230 V, 50 Hz, full load) ^③ | 0.95 |
| Output current tolerance ^④ | ± 7.5 % |
| Max. output current peak ^⑤ | ≤ output current + 12.5 % |
| Max. output voltage | 60 V |
| THD (at 230 V, 50 Hz, full load) ^⑥ | < 10 % |
| Output LF current ripple (< 120 Hz) | ± 5 % |
| Time to light (at 230 V, 50 Hz, full load) | < 0.5 s |
| Turn off time (at 230 V, 50 Hz, full load) | ≤ 0.5 s |
| Hold on time at power failure (output) | 0 s |
| Ambient temperature ta (at life-time 50,000 h) | 50 °C |
| Storage temperature ts | -40 ... +80 °C |
| Dimensions L x W x H | 115 x 43 x 30 mm |

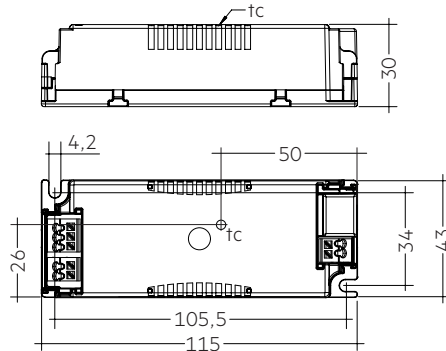

Ordering data

| Type | Article number | Packaging, carton | Packaging, pallet | Weight per pc. |
|--------------------------------|----------------|-------------------|-------------------|----------------|
| LC 50W 900-1200mA flexC SC ADV | 28002479 | 15 pc(s). | 1,800 pc(s). | 0.124 kg |

Specific technical data

| Type | Output current ^② | Min. forward voltage | Max. forward voltage | Max. output power | Typ. power consumption (at 230 V, 50 Hz, full load) | Typ. current consumption (at 230 V, 50 Hz, full load) | Max. casing temperature tc | Ambient temperature ta max. | Output select | Resistor ^④ |
|--------------------------------|-----------------------------|----------------------|----------------------|-------------------|---|---|----------------------------|-----------------------------|---------------|-----------------------|
| LC 50W 900-1200mA flexC SC ADV | 900 mA | 27 V | 43 V | 38.7 W | 44.5 W | 190 mA | 80 °C | -20 ... +50 °C | open | - |
| | 950 mA | 27 V | 44 V | 41.8 W | 46.3 W | 205 mA | 80 °C | -20 ... +50 °C | 0-1 | ADV Type E |
| | 1000 mA | 27 V | 44 V | 44.0 W | 48.5 W | 215 mA | 80 °C | -20 ... +50 °C | 0-1 | ADV Type A |
| | 1050 mA | 27 V | 44 V | 46.2 W | 51.2 W | 230 mA | 80 °C | -20 ... +50 °C | 0-2 | ADV Type F |
| | 1200 mA | 31 V | 43 V | 51.6 W | 56.5 W | 250 mA | 80 °C | -20 ... +50 °C | 0-2 | ADV Type A |

^① Test result at 1,200 mA.

^② Output current is mean value.

^③ Test result at 25 °C.

^④ Type A is a short circuit plug (0 Ω).



Strain-relief set 43x30mm

Product description

- Optional strain-relief set for independent applications
- Transforms the LED Driver into a fully class II compatible LED Driver (e.g. ceiling installation)
- Easy and tool-free mounting to the LED Driver, screwless cable-clamp channels for long strain-relief (30 x 43 x 30 mm)
- With screws for short strain-relief (15 x 34 x 30 mm)
- Overall length = length L (LED Driver) + 2 x 30 mm (long strain-relief set), 2 x 15 mm (short strain-relief) or long and short strain-relief any combination
- Standard SC (L = 30 mm) available as non-pre-assembled and pre-assembled
- Short SC (L = 15 mm) only pre-assembled available



ACU SC 30x43x30mm CLIP-ON SR SET ACU SC 30x43x30mm CLIP-ON SR SET 300
(28001168, non-pre-assembled) (28001351, non-pre-assembled, 300 pcs. packaging)



ACU SC 30x43x30mm CLIP-ON SR PA
(28001699, pre-assembled)

ACU SC 15x43x30mm CLIP-ON SR PA
(28001574, pre-assembled)

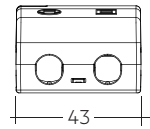
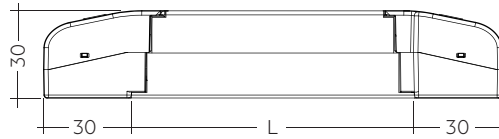

Permissible
cable jacket
diameter:
2.2 – 9 mm

ACU SC 30x43x30mm CLIP-ON SR SET / PA

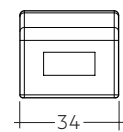
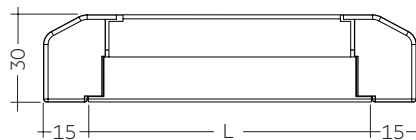

Permissible
cable jacket
diameter:
3 – 9 mm

ACU SC 15x43x30mm CLIP-ON SR PA

Ordering data

| Type | Article number | Packaging carton [®] | Packaging outer box | Weight per pc. |
|--|-----------------|-------------------------------|---------------------|----------------|
| ACU SC 43x30mm CLIP-ON SR SET | 28001168 | 10 pc(s). | 500 pc(s). | 0.021 kg |
| ACU SC 43x30mm CLIP-ON SR SET 300 | 28001351 | 300 pc(s). | 300 pc(s). | 0.021 kg |
| ACU SC 30x43x30mm CLIP-ON SR PA | 28001699 | 10 pc(s). | 500 pc(s). | 0.021 kg |
| ACU SC 15x43x30mm CLIP-ON SR PA | 28001574 | 10 pc(s). | 1,200 pc(s). | 0.010 kg |

[®] 28001168: A carton of 10 pcs. is equal to 10 sets, each with 2 strain-reliefs parts.

28001351: A carton of 300 pcs. is equal to 300 sets, each with 2 strain-reliefs parts.

28001699 + 28001574: A carton contains exactly 10 pcs. strain-reliefs (no sets).

Product description

- Ready-for-use resistor to set output current value
- Compatible with LED Driver serie LC flexC ADV;
not compatible with I-select (generation 1) and
I-select 2 (generation 2)
- Resistor is base isolated
- When using your own resistors, make sure the resistor must be
isolated
- Resistor power 0.25 W
- Current tolerance $\pm 2\%$ additional to output current tolerance
- Hot plug of the resistor is not permitted
- For detailed current setting see table "Specific technical data" of
the respective LED Driver and chapter 3.8 Current setting

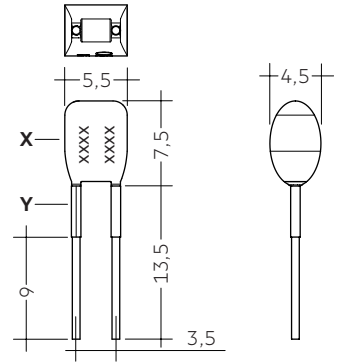

Ordering data

| Type | Article number | Colour of X area | Colour of Y area | Marking | Resistor value | Packaging bag | Weight per pc. |
|---------------------------|-----------------|------------------|------------------|---------|----------------|---------------|----------------|
| ADV Plug Type A YL | 28001771 | Yellow | Yellow | A | 0 Ω | 10 pc(s). | 0.001 kg |
| ADV Plug Type E YL | 28002096 | Yellow | Brown | E | 100 Ω | 10 pc(s). | 0.001 kg |
| ADV Plug Type F YL | 28002097 | Yellow | Grey | F | 30 Ω | 10 pc(s). | 0.001 kg |

1. Standards

EN 55015
EN 61000-3-2
EN 61000-3-3
EN 61347-1
EN 61347-2-13
EN 61547
EN 62384

1.1 Glow-wire test

according to EN 61347-1 with increased temperature of 850 °C passed.

2. Thermal details and life-time

2.1 Expected life-time

Expected life-time

| Type | ta | 40 °C | 50 °C |
|---------------------------------------|-----------|--------------------|--------------------|
| LC 50W 900-1200mA flexC SC ADV | tc | 70 °C [Ⓢ] | 80 °C [Ⓢ] |
| | Life-time | 100,000 h | 50,000 h |

[Ⓢ] Test result at max. output voltage.

The LED Drivers are designed for a life-time stated above under reference conditions and with a failure probability of less than 10 %.

3. Installation / wiring

3.1 Circuit diagram

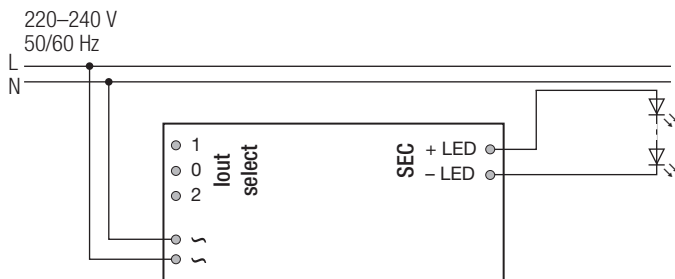

3.2 Wiring type and cross section

The wiring can be in stranded wires with ferrules or solid with a cross section of 0.5–1.5 mm². Strip 8.5–9.5 mm of insulation from the cables to ensure perfect operation of the push-wire terminals. Use one wire for each terminal connector only.

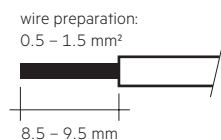

3.3 Release of the wiring

Press down the “push button” and remove the cable from front.

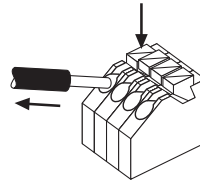

3.4 Fixing conditions when using as independent Driver with Clip-On

Dry, acidfree, oilfree, fatfree. It is not allowed to exceed the maximum ambient temperature (ta) stated on the device. Minimum distances stated below are recommendations and depend on the actual luminaire. Is not suitable for fixing in corner.

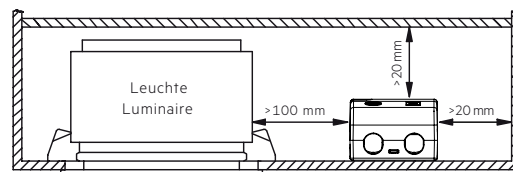

3.5 Wiring guidelines

- All connections must be kept as short as possible to ensure good EMI behaviour.
- Mains leads should be kept apart from LED Driver and other leads (ideally 5 – 10 cm distance)
- Max. length of output wires is 2 m.
- The secondary wires (LED module) should be routed in parallel to ensure good EMC performance.
- Secondary switching is not permitted.
- Incorrect wiring can damage LED modules.
- To avoid the damage of the Driver, the wiring must be protected against short circuits to earth (sharp edged metal parts, metal cable clips, louver, etc.).

3.6 Replace LED module

1. Mains off
2. Remove LED module
3. Wait for 20 seconds
4. Connect LED module again

Hot plug-in or secondary switching of LEDs is not permitted and may cause a very high current to the LEDs.

3.7 Installation instructions

The LED module and all contact points within the wiring must be sufficiently insulated against 3 kV surge voltage.

Air and creepage distance must be maintained.

3.8 Current setting

900 mA: All terminals open

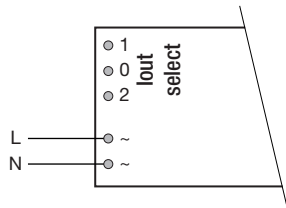

950 mA: Terminal 0 and 1 connected with resistor ADV Plug Type E BR (article number: 28002096)

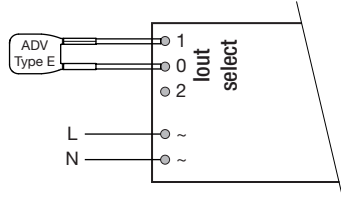

1,000 mA: Terminal 0 and 1 connected with 0 Ω wire (max. 6 cm length) or resistor ADV Plug Type A BR (article number: 28001771)

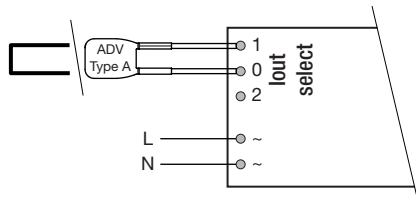

1,050 mA: Terminal 0 and 2 connected with resistor ADV Plug Type F BR (article number: 28002097)

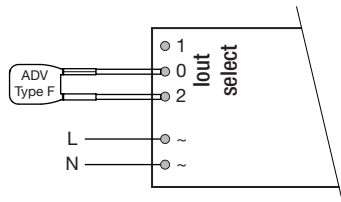

1,200 mA: Terminal 0 and 2 connected with 0 Ω wire (max. 6 cm length) or resistor ADV Plug Type A BR (article number: 28001771)

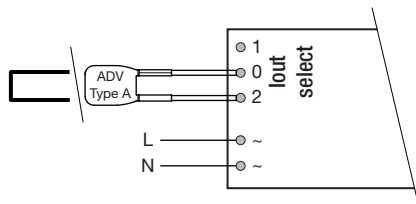

3.9 Mounting of device

Max. torque for fixing: 0.5 Nm/M4

4. Electrical values

4.1 Efficiency vs load

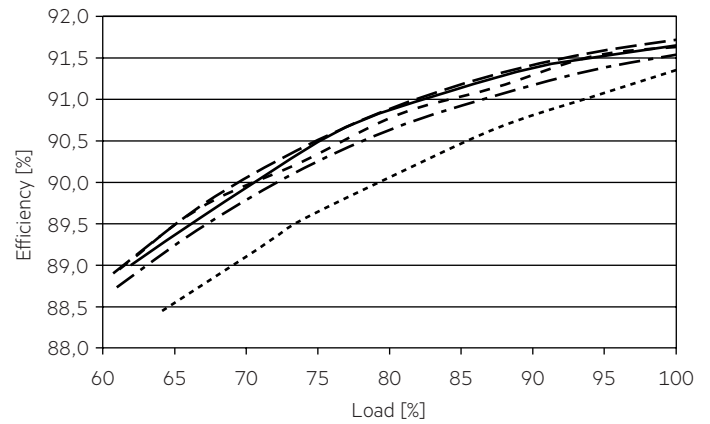

4.2 Power factor vs load

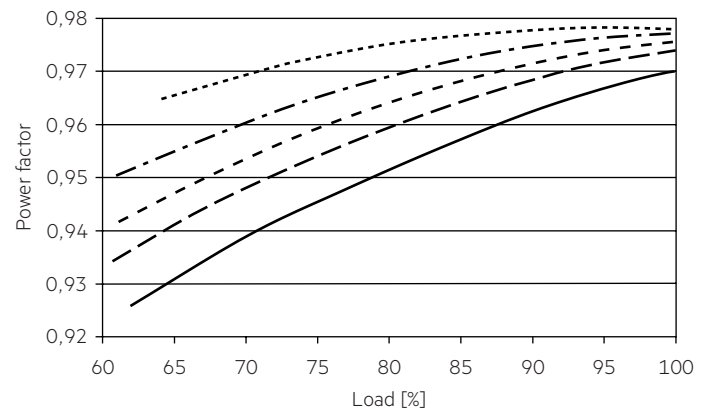

4.3 Input power vs load

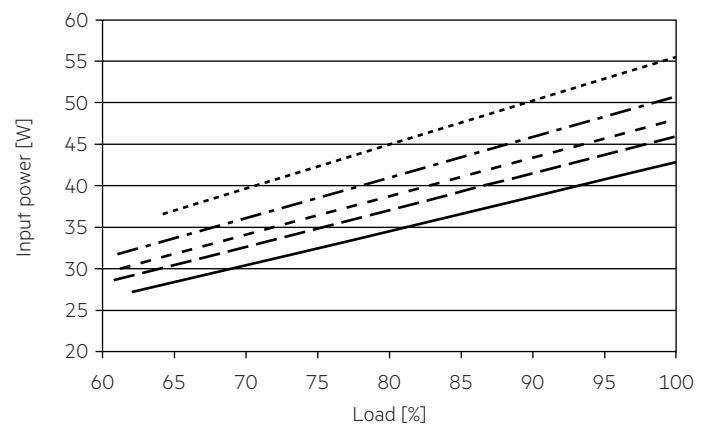

4.4 Input current vs load

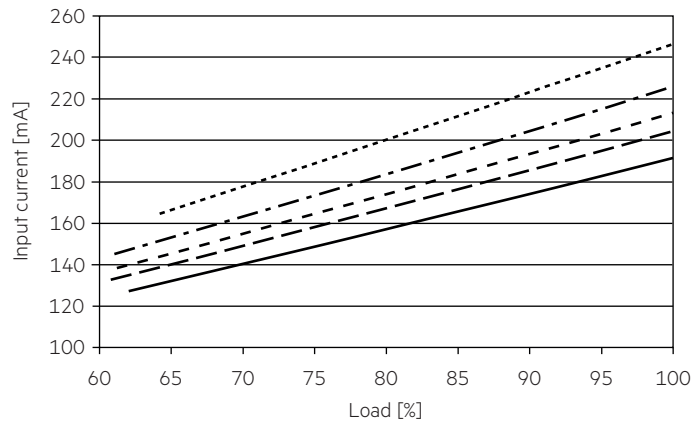

4.5 THD vs load

THD without harmonic < 5 mA (0.6 %) of the input current:

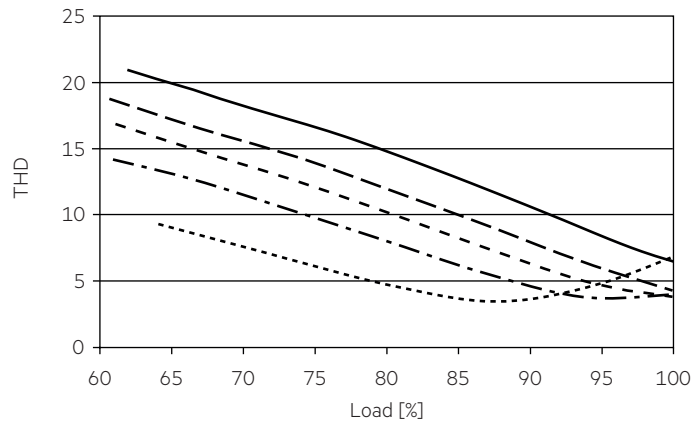

- 900 mA
- - - 950 mA
- - - - 1000 mA
- · - · - 1050 mA
- · · · · 1200 mA

4.3 Maximum loading of automatic circuit breakers

| Automatic circuit breaker type | C10 | C13 | C16 | C20 | B10 | B13 | B16 | B20 | Inrush current |
|---------------------------------------|---------------------|---------------------|---------------------|---------------------|---------------------|---------------------|---------------------|---------------------|------------------------------|
| Installation Ø | 1.5 mm ² | 1.5 mm ² | 1.5 mm ² | 2.5 mm ² | 1.5 mm ² | 1.5 mm ² | 1.5 mm ² | 2.5 mm ² | <i>I</i> _{max} Time |
| LC 50W 900-1200mA flexC SC ADV | 15 | 22 | 29 | 35 | 8 | 11 | 15 | 18 | 25 A 250 µs |

4.4 Harmonic distortion in the mains supply (at 230 V / 50 Hz and full load) in %

| | THD | 3. | 5. | 7. | 9. | 11. |
|---------------------------------------|------|------|-----|-----|-----|-----|
| LC 50W 900-1200mA flexC SC ADV | < 10 | < 10 | < 5 | < 5 | < 3 | < 3 |

Acc. to 6100-3-2. Harmonics < 5 mA or < 0.6 % (whatever is greater) of the input current are not considered for calculation of THD.

5. Functions

5.1 Short-circuit behaviour

In case of a short circuit on the secondary side (LED) the LED Driver switches off. After elimination of the short-circuit fault the LED Driver will recover automatically.

5.2 No-load operation

The LED Driver works in burst working mode to provide a constant output voltage regulation which allows the application to be able to work safely when LED string opens due to a failure.

5.3 Overload protection

If the output voltage range is exceeded, the LED Driver will protect itself and LED may flicker. After elimination of the overload the nominal operation will recover automatically.

5.4 Overtemperature protection

The LED Driver is protected against temporary thermal overheating. If the temperature limit is exceeded the LED-Driver will switch off. It restarts automatically.

6. Miscellaneous

6.1 Isolation and electric strength testing of luminaires

Electronic devices can be damaged by high voltage. This has to be considered during the routine testing of the luminaires in production.

According to IEC 60598-1 Annex Q (informative only!) or ENEC 303-Annex A, each luminaire should be submitted to an isolation test with 500 V_{DC} for 1 second. This test voltage should be connected between the interconnected phase and neutral terminals and the earth terminal. The isolation resistance must be at least 2 MΩ.

As an alternative, IEC 60598-1 Annex Q describes a test of the electrical strength with 1500 V_{AC} (or 1.414 x 1500 V_{DC}). To avoid damage to the electronic devices this test must not be conducted.

6.2 Conditions of use and storage

Humidity: 5% up to max. 85%,
not condensed
(max. 56 days/year at 85%)

Storage temperature: -40 °C up to max. +80 °C

The devices have to be within the specified temperature range (ta) before they can be operated.

6.3 Additional information

Additional technical information at www.tridonic.com → Technical Data

Guarantee conditions at www.tridonic.com → Services

Life-time declarations are informative and represent no warranty claim. No warranty if device was opened.