

Driver LC 40W 900mA fixC SR SNC
ESSENCE series

Product description

- Independent fixed output LED Driver
- Constant current LED Driver
- Output current 900 mA
- Max. output power 39 W
- Nominal life-time up to 50,000 h
- For luminaires of protection class I and protection class II
- For luminaires with M and MM as per EN 60598, VDE 0710 and VDE 0711
- Temperature protection as per EN 61347-2-13 C5e
- 5-year guarantee



Properties

- Casing: polycarbonat, white
- Type of protection IP20

Functions















- Overtemperature protection
- Overload protection
- Short-circuit protection
- No-load protection



Standards, page 3

Wiring diagrams and installation examples, page 4



IP20 SELV                            
RoHS

Driver LC 40W 900mA fixC SR SNC
ESSENCE series

Technical data

Rated supply voltage	220 – 240 V
AC voltage range	198 – 264 V
Input current (at 230 V, 50 Hz, full load)	0.2 A
Mains frequency	50 / 60 Hz
Typ. power consumption (at 230 V, 50 Hz, full load)	43.5 W
Max. input power	46 W
Output power range	27 – 39 W
THD (at 230 V, 50 Hz, full load)	< 20 %
Output current tolerance [®]	± 7.5 %
Typ. current ripple (at 230 V, 50 Hz, full load)	± 30 %
Turn on time (at 230 V, 50 Hz, full load)	≤ 0.5 s
Turn off time (at 230 V, 50 Hz, full load)	≤ 0.5 s
Hold on time at power failure (output)	0 s
Ambient temperature ta	-20 ... +50 °C
Ambient temperature ta (at life-time 50,000 h)	40 °C
Max. casing temperature tc	90 °C
Storage temperature ts	-40 ... +80 °C
Dimensions L x W x H	130 x 68 x 31 mm

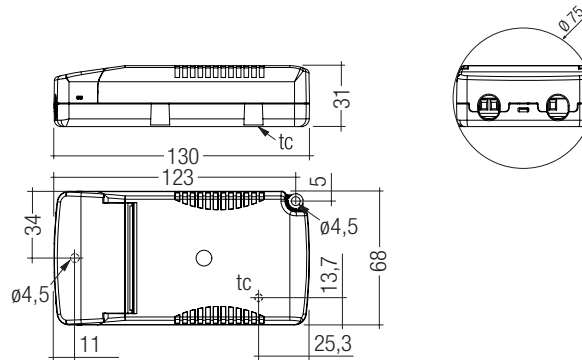

Ordering data

Type	Article number	Packaging, carton	Packaging, low volume	Packaging, high volume	Weight per pc.
LC 40W 900mA fixC SR SNC	87500551	30 pc(s).	390 pc(s).	1,950 pc(s).	0.152 kg

Specific technical data

Type	Output current [®]	Power factor at full load [®]	Efficiency at full load [®]	Power factor at min. load [®]	Efficiency at min. load [®]	Min. forward voltage	Max. forward voltage	Max. output voltage	Max. output peak current at full load [®]	Max. output peak current at min. load [®]
LC 40W 900mA fixC SR SNC	900 mA	0.96	91 %	0.93C	90 %	30 V	43 V	54 V	1,260 mA	1,440 mA

[®] Test result at 230 V, 50 Hz.

[®] The trend between min. and full load is linear.

[®] Output current is mean value.

Standards

EN 55015
EN 60598-1
EN 61000-3-2
EN 61000-3-3
EN 61347-1
EN 61347-2-13
EN 61547

Overload protection

If the output voltage range is exceeded the LED Driver will protect itself and LED may flicker. After elimination of the overload, the nominal operation is restored automatically.

Overtemperature protection

The LED Driver is protected against temporary thermal overheating. If the temperature limit is exceeded, the output current is reduced to limit t_c at a certain level. The temperature protection is activated typically at 10 °C above t_c max.

Short-circuit behaviour

In case of a short circuit on the secondary side (LED) the LED Driver switches into hic-cup mode. After elimination of the short-circuit fault the LED Driver will recover automatically.

No-load operation

The LED Driver works in burst working mode to provide a constant output voltage regulation which allows the application to be able to work safely when LED string opens due to a failure.

Installation instructions

The LED module and all contact points within the wiring must be sufficiently insulated against 3 kV surge voltage. Air and creepage distance must be maintained.

Replace LED module

1. Mains off
2. Remove LED module
3. Wait for 10 seconds
4. Connect LED module again

Hot plug-in or secondary switching of LEDs is not permitted and may cause a very high current to the LEDs.

Expected life-time

Type	t_a	40 °C	50 °C	60 °C
LC 40W 900mA fixC SR SNC	t_c	80 °C	90 °C	x
	Life-time	50,000 h	30,000 h	x

The LED Driver is designed for a life-time stated above under reference conditions and with a failure probability of less than 10 %.

Maximum loading of automatic circuit breakers

Automatic circuit breaker type	C10	C13	C16	C20	B10	B13	B16	B20	Inrush current
Installation \varnothing	1.5 mm ²	1.5 mm ²	1.5 mm ²	2.5 mm ²	1.5 mm ²	1.5 mm ²	1.5 mm ²	2.5 mm ²	I_{max} Time
LC 40W 900mA fixC SR SNC	40	55	70	85	35	55	70	85	10 A 100 μ s

Harmonic distortion in the mains supply (at 230 V / 50 Hz and full load) in %

	THD	3.	5.	7.	9.	11.
LC 40W 900mA fixC SR SNC	20	10	2	2	2	1

Fixing conditions

Dry, acidfree, oilfree, fatfree. It is not allowed to exceed the maximum ambient temperature (t_a) stated on the device. Minimum distances stated below are recommendations and depend on the actual luminaire. Is not suitable for fixing in corner.

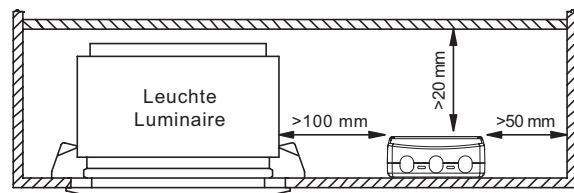

Storage conditions

Humidity: 5 % up to max. 85 %
not condensed
(max. 56 days/year at 85 %)

Storage temperature: -40 °C up to max. +80 °C

The devices have to be within the specified temperature range (t_a) before they can be operated.

Wiring diagram

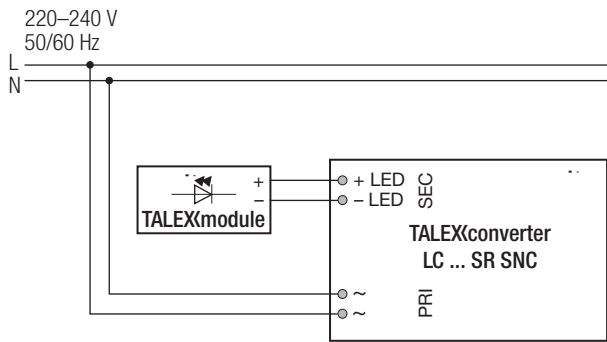

Glow wire test

according to EN 60598-1 with increased temperature of 850 °C passed.

Isolation and electric strength testing of luminaires

Electronic devices can be damaged by high voltage. This has to be considered during the routine testing of the luminaires in production.

According to IEC 60598-1 Annex Q (informative only!) or ENEC 303-Annex A, each luminaire should be submitted to an isolation test with 500 V_{DC} for 1 second. This test voltage should be connected between the interconnected phase and neutral terminals and the earth terminal. The isolation resistance must be at least 2 MΩ.

As an alternative, IEC 60598-1 Annex Q describes a test of the electrical strength with 1500 V_{AC} (or 1.414 × 1500 V_{DC}). To avoid damage to the electronic devices this test must not be conducted.

Additional information

Additional technical information at www.tridonic.com → Technical Data

Guarantee conditions at www.tridonic.com → Services

Life-time declarations are informative and represent no warranty claim. No warranty if device was opened.

Wiring type and cross section

The wiring can be in stranded wires with ferrules or solid. For perfect function of the cage clamp terminals the strip length should be 4 – 5 mm for the input terminal.

The max. torque at the clamping screw (M3) is 0.2 Nm.

Use one wire for each terminal connector only.

Use each strain relief channel for one cable only.

Input / Output terminal

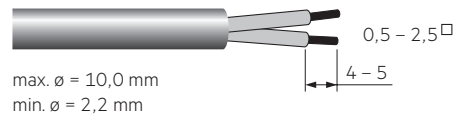

Wiring instructions

- All connections must be kept as short as possible to ensure good EMI behaviour
- Mains leads should be kept apart from LED Driver and other leads (ideally 5 – 10 cm distance)
- The maximum length of output wires is 2 m.
- Secondary switching is not permitted.
- Incorrect wiring can damage LED modules.
- The wiring must be protected against short circuits to earth (sharp edged metals parts, metal cable clips, louver, etc.)

Diagrams LC 40W 900mA fixC SR SNC

Efficiency vs load

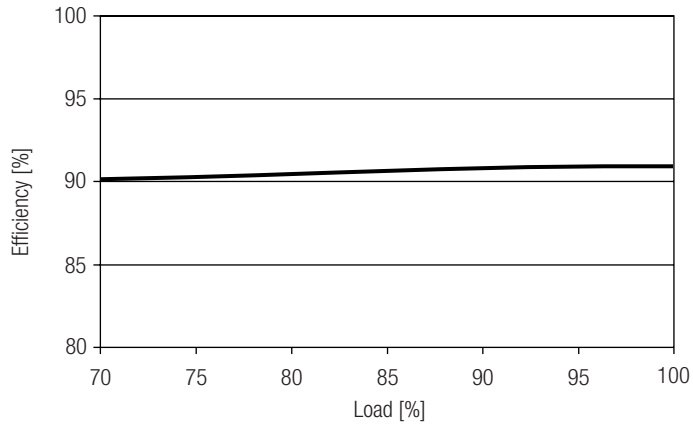

Power factor vs load

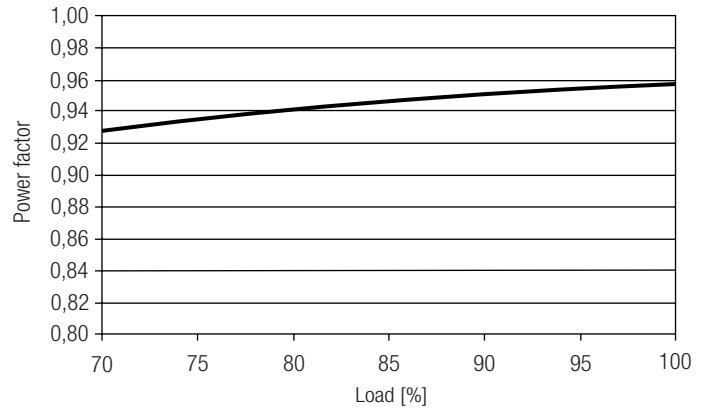

Input power vs load

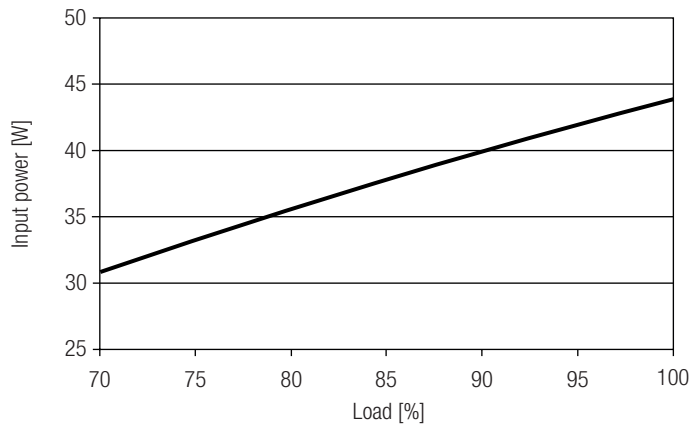

Input current vs load

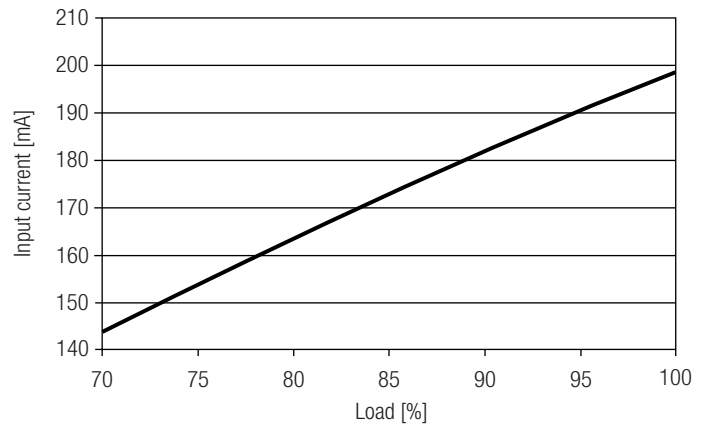

THD vs load

