

# PHILIPS

## Xitanium

### LED driver



## Datasheet

### Xitanium Round Shape High Bay LED Drivers WL Independent

Xi 240W 0.82-1.35A WL RI129

9290 034 02880

The Xitanium Round Shape High Bay LED Drivers are designed to deliver highly reliable and efficient LED drivers in industrial applications. They are long-lasting and require low maintenance. The Wideline family is an upgraded portfolio with purpose to provide more stable and reliable industry drivers to OEM customers and end-users. The product could withstand input voltage 100-277V<sub>ac</sub> anywhere around the world and ensure 100% performance from 200-254V<sub>ac</sub>.

#### Benefits

- Reliable and robust design, capable of withstanding the harsh industrial operating conditions
- Wide flexibility by adjusting output current and compact housing
- Long lifetime, fitting with high bay industrial applications
- Peace of mind, backed by a 5-year warranty from a company you can trust

#### Features

- 100-277V input voltage
- Independent/IP65 rated
- Adjustable output current
- High ambient temperature rating, up to 60°C
- Approbation: CE, ENEC, CB, CCC, UKCA, RCM
- 50,000 hours lifetime

#### Application

- Highbay industrial lighting
- Warehouse lighting
- Big-box retail store lighting

## Electrical input data

Specification item	Value	Unit	Condition
Rated input voltage range	200...254	V <sub>ac</sub>	Performance range
Rated input voltage	230	V <sub>ac</sub>	
Rated input frequency range	50...60	Hz	Performance range
Rated input current	1.1	A	@ rated output power @ rated input voltage
Rated input power	252	W	@ rated output power @ rated input voltage
Power factor	0.95		@ rated output power @ rated input voltage
Total harmonic distortion	10	%	@ rated output power @ rated input voltage
Efficiency	96	%	@ rated output power @ rated input voltage @ max. U <sub>out</sub>
Input voltage AC range	85...305	V <sub>ac</sub>	Operational range
Input frequency AC range	47...63	Hz	Operational range

## Electrical output data

Specification item	Value	Unit	Condition
Regulation method	Constant Current		
Output voltage	160...260	V <sub>dc</sub>	
Output voltage max.	300	V	Maximum output voltage (rms)
Output current	0.82...1.35	A	
Output current tolerance ±	5	%	
Output current ripple LF	≤ 5	%	Ripple = peak / average, < 3kHz
Output current ripple HF	≤ 5	%	
Output P <sub>st</sub> <sup>LM</sup>	≤ 0.1		In entire operating window
Output SVM	≤ 0.1		In entire operating window
Output power	131...240	W	
Rated output power	240	W	

## Electrical data controls input

Specification item	Value	Unit	Condition
Control method	Fixed		

## Wiring and Connections

Specification item	Value	Unit	Type
Input wire cross-section	1 / 17	mm <sup>2</sup> / AWG	3x 1.0mm <sup>2</sup> stranded wires, waterproof cable
Output wire cross-section	1 / 17	mm <sup>2</sup> / AWG	2x 1.0mm <sup>2</sup> stranded wires, waterproof cable
Maximum cable length	2	m	Total length of wiring including LED module, one way

## Insulation

Insulation per IEC61347-1	Mains	Output	Ground
Mains		Non	Basic
Output	Non		Basic
Ground	Basic	Basic	

## Dimensions and weight

Specification item	Value	Unit	Tolerance (mm)
Length (A1)	129	mm	
Mounting hole distance (A2)	24	mm	
Width (B1)	113	mm	
Width (B2)	113	mm	
Height (C1)	68	mm	
Height (C2)	46	mm	
Input cable length (E1)	1500	mm	
Output cable length (E2)	300	mm	
Weight	900	gram	

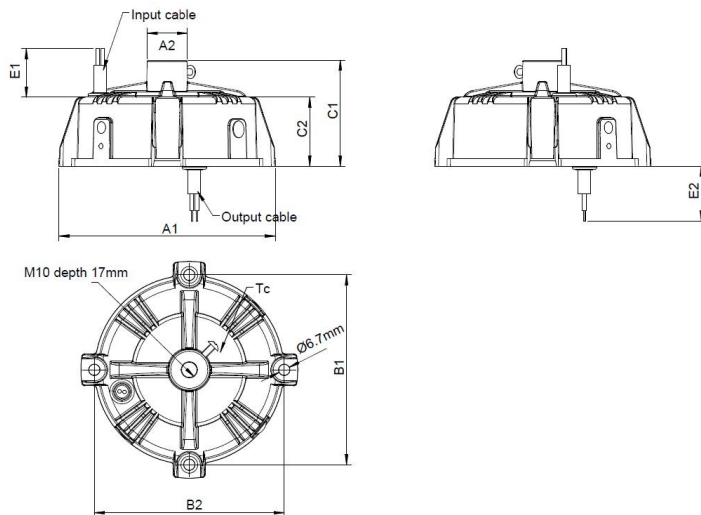

## Logistical data

Specification item	Value
Product name	Xi 240W 0.82-1.35A WL RI129
Logistic code 12NC	9290 034 02880
Pieces per box	10

## Operational temperatures and humidity

Specification item	Value	Unit	Condition
Ambient temperature	-40...+60	°C	Higher ambient temperature allowed as long as Tcase-max is not exceeded
Tcase-max	80	°C	Maximum temperature measured at T <sub>case</sub> -point
Tcase-life	70	°C	Measured at T <sub>case</sub> -point
Relative humidity	10...90	%	Non-condensing

## Lifetime

Specification item	Value	Unit	Condition
Driver lifetime	50,000	hours	Measured temperature at Tcase-point is Tcase-max. Maximum failures = 10%

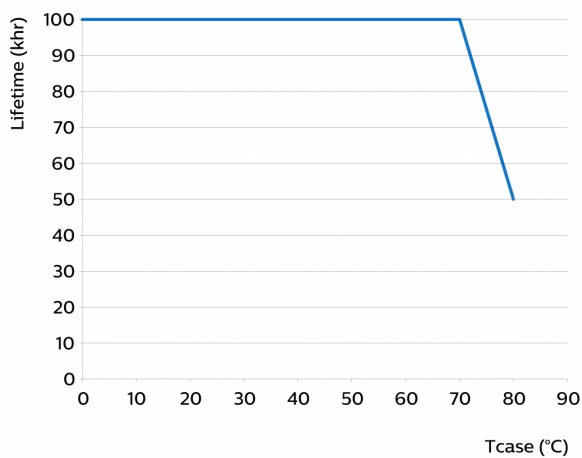

## Storage temperature and humidity

Specification item	Value	Unit	Condition
Ambient temperature	-40...+85	°C	
Relative humidity	5...95	%	Non-condensing

## Programmable features

Specification item	Available	Default setting	Condition
Set Adjustable Output Current (AOC)		820 mA	

## Features

Specification item	Value	Condition
Open load protection	Yes	Automatic recovering
Short circuit protection	Yes	Automatic recovering
Hot wiring	No	
Suitable for fixtures with protection class	I	per IEC60598
Overtemperature protection	Yes	Automatic recovering

## Inrush current

Specification item	Value	Unit	Condition
Inrush current	50	A	Input voltage 230V
Inrush peak width	430	$\mu$ s	Input voltage 230 V, measured at 50% height
Drivers / MCB 16A type B	$\leq 5$	pcs	Indicative value

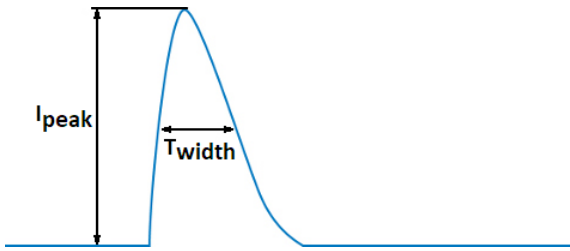

Please refer to the driver design in guide if you use other MCB-types.

## Driver touch current / protective conductor current

Specification item	Value	Unit	Condition
Typical Protective Conductor Current (ins. Class I)	2	mA rms	Acc. IEC60598-1. LED module contribution not included

## Surge immunity

Specification item	Value	Unit	Condition
Mains surge immunity (diff. mode)	4	kV	Acc. IEC61000-4-5. 2 Ohm, 1.2/50us, 8/20us
Mains surge immunity (comm. mode)	4	kV	Acc. IEC61000-4-5. 12 Ohm, 1.2/50us, 8/20us

## Application Info

Specification item	Value
Approval marks	CB / CCC / CE / ENEC / RCM / UKCA
Ingress Protection classification (IP)	65
Application	Outdoor
Mounting Type	Independent

## Graphs

### Operating window

---

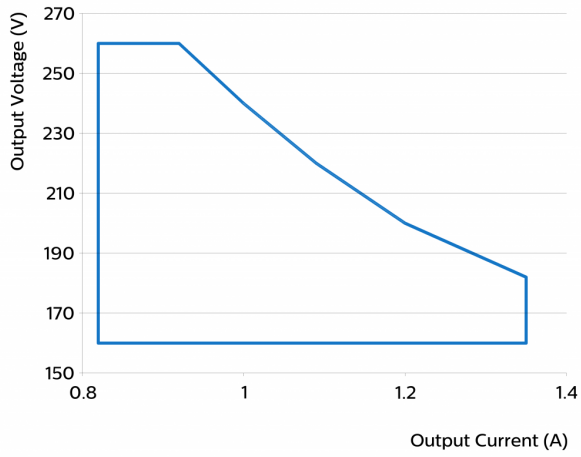

### Mains Guard

---

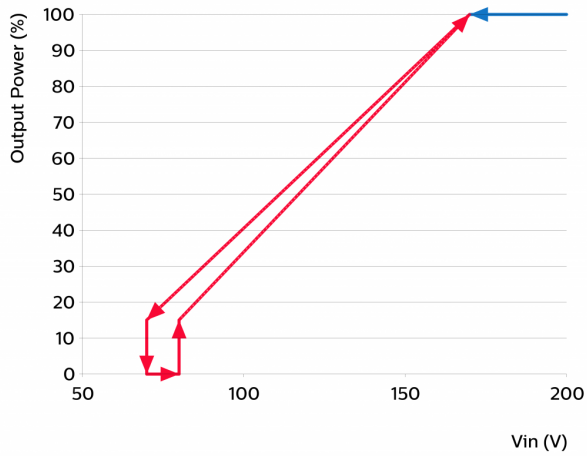

### Power factor versus output power

---

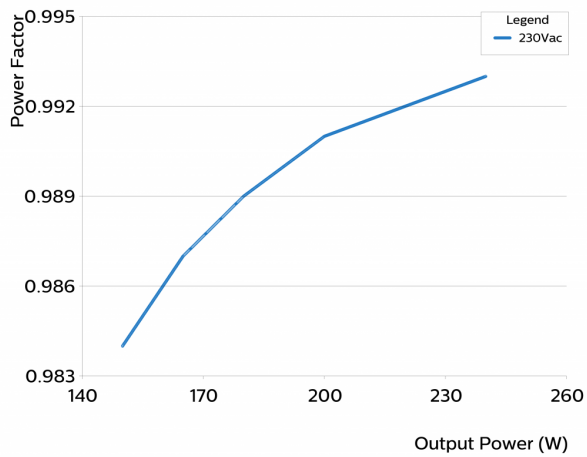

## Efficiency versus output power

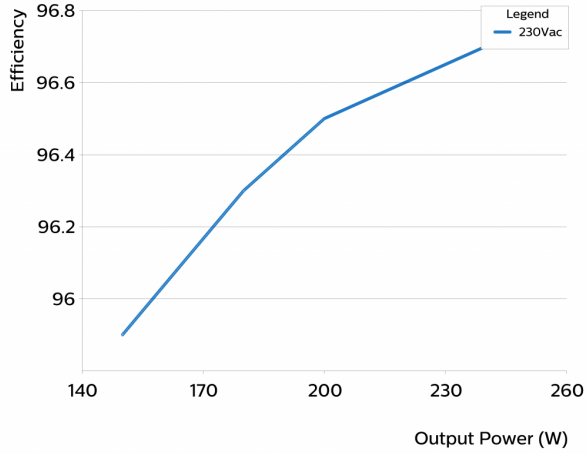

## THD versus output power

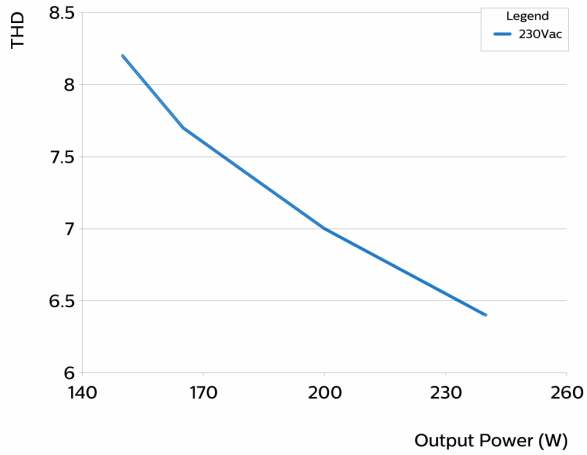

©2021 Signify Holding, IBRS 10461, 5600 VB, NL. All rights reserved.  
UK importer address: Signify Commercial UK Limited, 3, Guildford Business Park, GU2 8XG.

The information provided herein is subject to change without notice. Signify does not give any representation or warranty as to the accuracy or completeness of the information included herein and shall not be liable for any action in reliance thereon. The information presented in this document is not intended as any commercial offer and does not form part of any quotation or contract, unless otherwise agreed by Signify.

Philips and the Philips Shield Emblem are registered trademarks of Koninklijke Philips N.V. All other trademarks are owned by Signify Holding or their respective owners.

Date of release: September 24, 2021 v1

[www.philips.com/oem](http://www.philips.com/oem)