



# SOSEN LED Driver, Your Smart Choice

## Specifications

### SS-200VH Series LED Driver

Model: SS-200VH-XXX

Description: 200W LED Driver

Rev.: V04

Release Date: 2022-05-08

# SS-200VH Series LED Driver

**SOSEN**  
LED DRIVER



**LED DRIVER**

**VH Series**



## Features:

- Efficiency up to 94.5%
- Isolated dimming:0-10V,PWM,Resistor
- Timing and Negative logic programmable
- Communication Function With PC
- IP67
- Protections: SCP/OTP/OVP/OPP
- Type HL, suitable for hazardous locations
- Surge protection: CM: 10kV, DM: 6kV
- Warranty: 5 years



## Description:

VH series are constant current LED Driver with wide O/P voltage range and adjustable O/P current by program.LED luminaries manufactures can easily design luminaries and reduce cost.

### Applications:

High Pole lighting, High bay lighting,Stadium lighting,Plant lighting,Street lighting, Fish lighting,Stage lighting, Tunnel lighting

## Model List:

Model	AC Input Range	Max. Pout	Vout Range	Full Power Vo Range	Iout	Default Current	THD(Typ.)	PF(Typ.)	Eff.(Typ.)	Max.Tc
SS-200VH-56B	90-305Vac	201.6W	28-56V	36-56V	0.7-5.6A	4.8A	5%	0.98	94%	90°C
SS-200VH-E56B	90-305Vac	201.6W	28-56V	36-56V	0.7-5.6A	4.8A	5%	0.98	93%	90°C
SS-200VH-E286B	90-305Vac	200.2W	143-286V	190-286V	0.1-1.05A	1.05A	5%	0.98	94%	90°C

Note:

1.Default Tested: at 220Vac, full load, Ta 25°C.

2.The performance of the LED Driver can be guaranteed within the full power Vo range.The voltage lower than full power Vo range, it is need to test the performance with the LED module.

# SS-200VH Series LED Driver

## Input Characteristics(SS-200VH-56B):

Parameter	Min.	Typ.	Max.	Remark
Rated AC Input Range	100Vac		277Vac	Derate when <120Vac
AC Input Range	90Vac		305Vac	
Input Frequency Range	47Hz	50/60Hz	63Hz	
Max Input Current			2.3A	100Vac, Full load
Max Input Power			230W	100Vac, Full load
Max Inrush Current(120Vac)			60A	Cold start
Max Inrush Current(220Vac)			110A	Cold start
Max Inrush Current(277Vac)			125A	Cold start
No Load Power			5W	220Vac/50Hz, No load
Power Factor	0.97	0.98		220Vac/50Hz, Full load
	0.90			100-277Vac/50Hz, 70-100% load
THD		5%	10%	220Vac/50Hz, Full load
			20%	100-277Vac/50Hz, 70-100% load

# SS-200VH Series LED Driver

## Input Characteristics(SS-200VH-E56B/SS-200VH-E286B):

Parameter	Min.	Typ.	Max.	Remark
Rated AC Input Range	100Vac		176Vac	<Ta: 45°C , Derate when <120Vac
	176Vac		277Vac	<Ta: 55°C
AC Input Range	90Vac		305Vac	
Input Frequency Range	47Hz	50/60Hz	63Hz	
Max Input Current			2.3A	100Vac, Full load
Max Input Power			230W	100Vac, Full load
Max Inrush Current(120Vac)			60A	Cold start
Max Inrush Current(220Vac)			110A	Cold start
Max Inrush Current(277Vac)			125A	Cold start
No Load Power			7.5W	220Vac/50Hz, No load
Power Factor	0.97	0.98		220Vac/50Hz, Full load
	0.90			100-277Vac/50Hz, 70-100% load
THD		5%	10%	220Vac/50Hz, Full load
			20%	100-277Vac/50Hz, 70-100% load

# SS-200VH Series LED Driver

## O/P Characteristics(SS-200VH-56B):

Parameter	Min.	Typ.	Max.	Remark
O/P Voltage Range	28V		56V	Power derated @28-36V
Rated O/P Voltage	36V		56V	$P_o = V_o \cdot I_o = 201.6W$ , Full load
Rated O/P Current	3.6A		5.6A	5.6A for 36V, 3.6A for 56V
Adj. O/P Current (AOC) Range	0.7A		5.6A	AOC by programming
No Load Voltage			60V	
Efficiency @120Vac	89.0%	91.0%		O/P 36V/5.6A
Efficiency @220Vac	92.0%	94.0%		O/P 36V/5.6A
Efficiency @277Vac	92.0%	94.0%		O/P 36V/5.6A
O/P Current Tolerance	-5%		+5%	
O/P Current Ripple(PK-AV)		5%	10%	Full load
Start-up Current Overshoot			10%	Full load
Start-up Time			0.5S	120Vac, Full load
			0.5S	220Vac, Full load
Line Regulation	-2%		+2%	Full load
Load Regulation	-2%		+2%	
Temperature Coefficient	-0.03%/°C		+0.03%/°C	Tc: 0°C~90°C
OTP	90°C	100°C	110°C	>Tc Typ., Current derating <Tc Min., Current recovery
Short Circuit Protection			10W	Driver will not be damaged, Hiccup mode

# SS-200VH Series LED Driver

## O/P Characteristics(SS-200VH-E56B):

Parameter	Min.	Typ.	Max.	Remark
O/P Voltage Range	28V		56V	Power derated @28-36V
Rated O/P Voltage	36V		56V	$P_o = V_o * I_o = 201.6W$ , Full load
Rated O/P Current	3.6A		5.6A	5.6A for 36V, 3.6A for 56V
Adj. O/P Current (AOC) Range	0.7A		5.6A	AOC by programming
No Load Voltage			60V	
Efficiency @120Vac	88.0%	90.0%		O/P 36V/5.6A
Efficiency @220Vac	91.0%	93.0%		O/P 36V/5.6A
Efficiency @277Vac	91.0%	93.0%		O/P 36V/5.6A
O/P Current Tolerance	-5%		+5%	
O/P Current Ripple(PK-AV)		5%	10%	Full load
Start-up Current Overshoot			10%	Full load
Start-up Time			0.5S	120Vac, Full load
			0.5S	220Vac, Full load
Line Regulation	-2%		+2%	Full load
Load Regulation	-2%		+2%	
Temperature Coefficient	-0.03%/°C		+0.03%/°C	Tc: 0°C~90°C
OTP	90°C	100°C	110°C	>Tc Typ., Current derating <Tc Min., Current recovery
Short Circuit Protection			10W	Driver will not be damaged, Hiccup mode

# SS-200VH Series LED Driver

## O/P Characteristics(SS-200VH-E286B):

Parameter	Min.	Typ.	Max.	Remark
O/P Voltage Range	143V		286V	Power derated @143-190V
Rated O/P Voltage	190V		286V	$P_o = V_o \cdot I_o = 200.2W$ , Full load
Rated O/P Current	0.7A		1.05A	1.05A for 190V, 0.7A for 286V
Adj. O/P Current (AOC) Range	0.1A		1.05A	AOC by programming
No Load Voltage			310V	
Efficiency @120Vac	89.5%	91.5%		O/P 286V/0.7A
Efficiency @220Vac	92.0%	94.0%		O/P 286V/0.7A
Efficiency @277Vac	92.5%	94.5%		O/P 286V/0.7A
O/P Current Tolerance	-5%		+5%	
O/P Current Ripple(PK-AV)		5%	10%	Full load
Start-up Current Overshoot			10%	Full load
Start-up Time			0.5S	120Vac, Full load
			0.5S	220Vac, Full load
Line Regulation	-2%		+2%	Full load
Load Regulation	-2%		+2%	
Temperature Coefficient	-0.03%/°C		+0.03%/°C	Tc: 0°C~90°C
OTP	90°C	100°C	110°C	> Tc Typ., Current derating < Tc Min., Current recovery
Short Circuit Protection			10W	Driver will not be damaged, Hiccup mode

# SS-200VH Series LED Driver

## Other Characteristics:

Parameter		Min.	Typ.	Max.	Remark	
0-10V Positive Dimming (Configurable)	Dim Vmax	0V		12V	DIM+ source current 110uA. Dimming prohibits reverse connection Configurable to 0-5V	
	Dim Range	10%Iomax		100%Ioset		
	Rec.Dim Range	0V		10V		
10-0V Negative Dimming (Configurable)	Rec.Dim Range	0V		10V	DIM+ sink current I <sub>max</sub> 40uA. Dimming prohibits reverse connection Configurable to 5-0V	
PWM Dimming (Optional)	PWM High	9.8V		10.2V	DIM+ source current 110uA. Dimming prohibits reverse connection	
	PWM Low	0V		0.3V		
	Frequency	1KHz		2KHz		
	PWM Duty	0%		100%		
Resistor Dimming (Optional)	Resistance	0Kohm		100Kohm	Not available with negative logic	
	Dim Range	10%Iomax		100%Ioset	DIM+ source current 110uA .	
0-10V Dim to Off	Dim off	0.7V	0.8V	0.9V	If the led is less than maximum rated output voltage of 75%,the luminaries may possibly have slight light when dim-to-off. Thus the whole lighting system needs to be tested	
	Dim on	0.8V	0.9V	1.0V		
10-0V Dim to Off	Dim off	9.1V	9.3V	9.5V		
	Dim on	9.0V	9.2V	9.4V		
Timing Curve(Optional)		By programming				Set by program
Lifetime(Tc≤75°C)		≥62,000 hours(SS-200VH)				80% load
Lifetime(Tc≤75°C)		≥50,000 hours(SS-200VH-E56B)			80% load	
Lifetime(Tc≤78°C)		≥50,000 hours(SS-200VH-E286B)			80% load	
MTBF		213,000 hours(SS-200VH)			220Vac,Full load, Ta=25°C (MIL-HDBK-217F)	
MTBF		203,000 hours(SS-200VH-E)				
IP		IP67				
Tc		90°C				
Warranty	SS-200VH	5 years			Tc : 75°C	
	SS-200VH-E	5 years			Tc : 75°C	
Net Weight	SS-200VH	810g				
	SS-200VH-E	750g				
Dimension	SS-200VH	180mm*66mm*37mm			L x W x H	
	SS-200VH-E	165mm*66mm*37mm			L x W x H	

NOTE: All the parameters above are tested Ta 25°C and LED load, unless specified.



# SS-200VH Series LED Driver

## Environmental Requirements

Parameter	Min.	Typ.	Max.	Remark
Operating Temperature(Tcase)	-40°C	25°C	+90°C	
Storage Temperature	-40°C	25°C	+90°C	
Operation Humidity	10%RH		90%RH	
Storage Humidity	5%RH		95%RH	
Altitude	-65m		4000m	

## Safety and EMI/EMS Standards

Certification	Standard	Status (VH)	Status (VH-E)	Remark
UL/cUL	UL8750	✓	✓	VH-E286B Certification in progress
ENEC	EN 61347-1:2015 EN 61347-2-13:2014 EN 61347-2-13:2014/A1:2017	✓	✓	VH-E286B Certification in progress
UKCA	EN 61347-1:2015+A1:2021 EN 61347-2-13:2014+A1:2017 EN 62493:2015 BS EN 61347-1:2015+A1:2021 BS EN 61347-2-13:2014+A1:2017 BS EN 62493:2015		✓	VH-E286B Certification in progress
EAC	EN 61347-2-13:2014 EN61347-1:2008+A1:2011+A2:2013 TP TC 004/2011 TP TC 020/2011		✓	VH-E286B Certification in progress
RCM	AS/NZS61347.2.13	✓	✓	VH-E286B Certification in progress
CCC	GB 19510.14-2009	✓	✓	VH-E286B Certification in progress
CE	EN 61347-2-13:2014 EN61347-1:2008+A1:2011+A2:2013	✓	✓	VH-E286B Certification in progress

EMI/EMS	Criterion	Remark
Conduction Emission	EN IEC 55015:2019+A11:2020	
Radiation Emission	EN IEC 55015:2019+A11:2020	
Harmonic Current Emissions	IEC/EN 61000-3-2:2019+A1:2021	Class C
Surge	IEC/EN 61000-4-5	DM: 6kV,CM: 10kV,Criterion B
	ANSI/C82.77-5-2017(SS-200VH)	DM: 6kV,CM: 6kV,Criterion B
Ring Wave	IEC/EN 61000-4-12;ANSI/C82.77-5-2017	DM: 6kV,CM: 6kV,Criterion B

# SS-200VH Series LED Driver

## Safety Test Items:

Safety Test Items	Technical Indicators			Remark
	UL Insulation Requirements	ENEC Insulation Requirements	CCC Insulation Requirements	
Insulation Requirements	UL Insulation Requirements	ENEC Insulation Requirements	CCC Insulation Requirements	
Input-Output	1600Vac	3000Vac	3750Vac	Reinforced insulation
Input-Case	1600Vac	1500Vac	1875Vac	Basic insulation
Input-Dim	1600Vac	3000Vac	3750Vac	Reinforced insulation
Output-Dim	1600Vac	1000Vac	1000Vac	Basic insulation
Output-Case	500Vac	1000Vac	1000Vac	Basic insulation
Dim-Case	500Vac	250Vac	500Vac	Basic insulation
Insulation Resistance	≥10MΩ			Input-Output, Test voltage:500Vdc
Ground Resistance	≤0.1Ω			25A/1min
Leakage Current	≤0.75mA			277Vac

### NOTE:

1. SOSEN warrants the LED Driver itself complies with EMC standard. However, LED Driver's EMC should be re-checked when integrated into lighting systems due to unexpected interference of components.
2. Please short (ACL and ACN), (V+ and V-), (Dim+ and Dim -) when Hi-pot test.
3. The CCC withstand voltage test needs to disconnect the built-in lightning protection tube. According to the IEC 60598-1:14 standard section 10.2, the "built-in lightning protection tube" can be marked on the nameplate to disconnect the discharge tube on testing.

## Performance Curves:

### Input Inrush Current

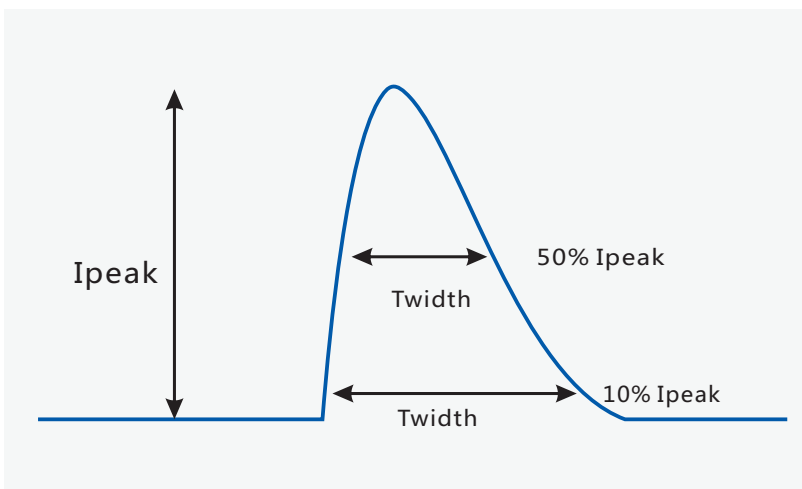

Vin	Ipeak	T(@10% of Ipeak)	T(@50% of Ipeak)
120Vac	60A	750uS	
220Vac	110A		300uS
277Vac	125A	550uS	

# SS-200VH Series LED Driver

## Performance Curves:

O/P Voltage Vs. O/P Current(Dim/AOC Window)

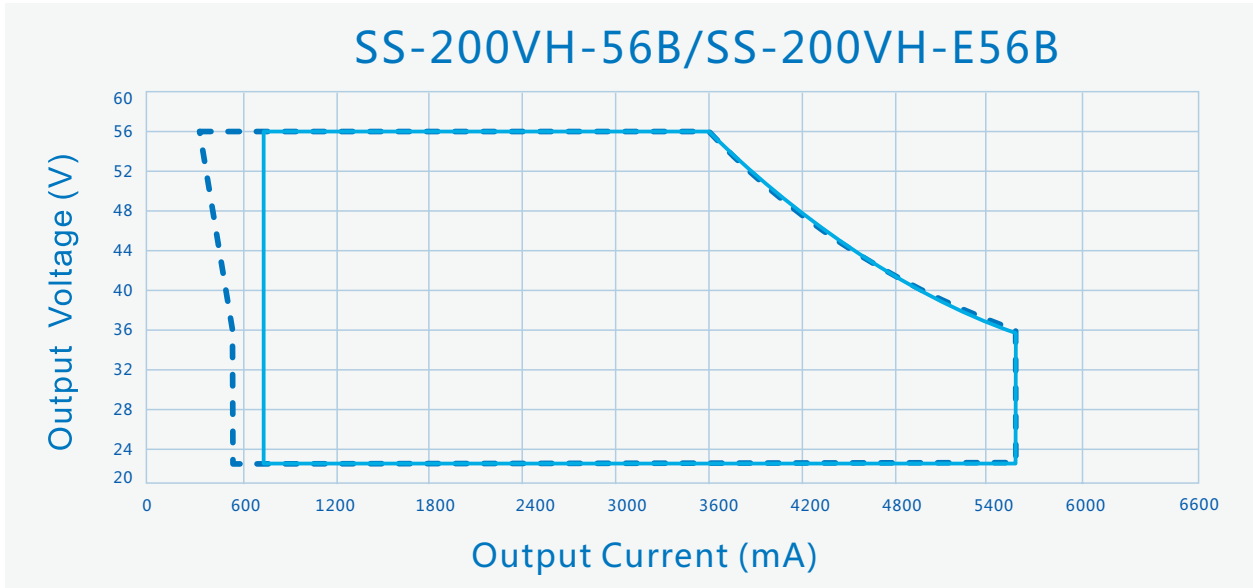

----- Dimming Window      ————— AOC Window

O/P Voltage Vs. O/P Current(Dim/AOC Window)

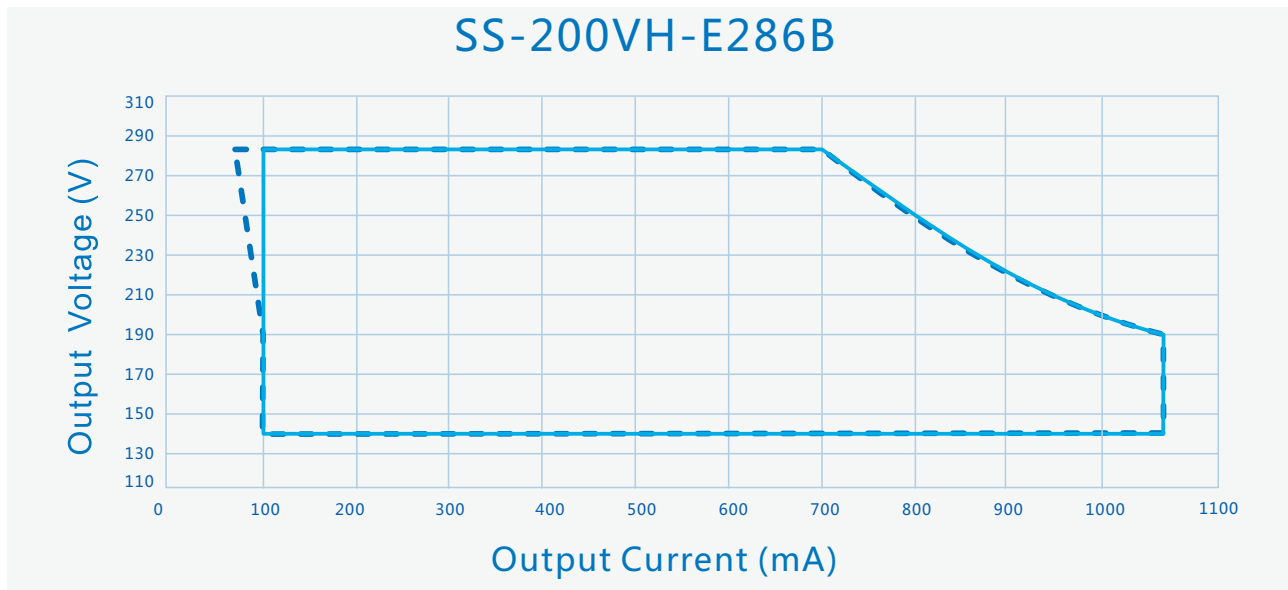

----- Dimming Window      ————— AOC Window

# SS-200VH Series LED Driver

## Performance Curves:

Efficiency Vs. O/P Voltage ( $V_{in}=120Vac$ )

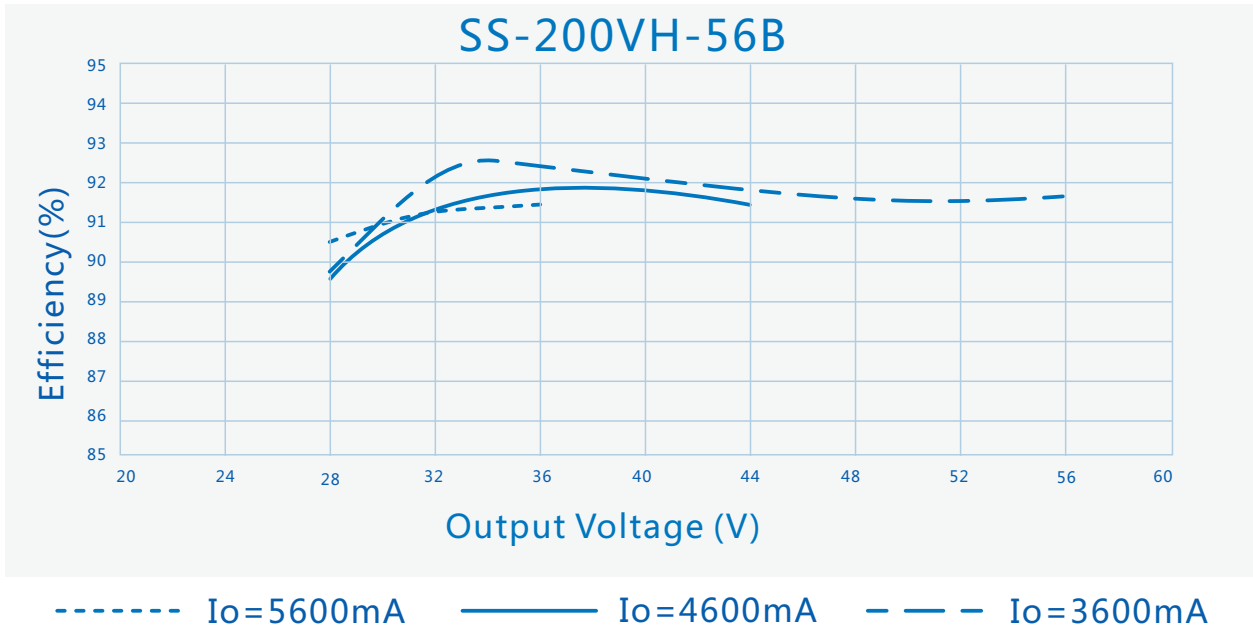

Efficiency Vs. O/P Voltage ( $V_{in}=220Vac$ )

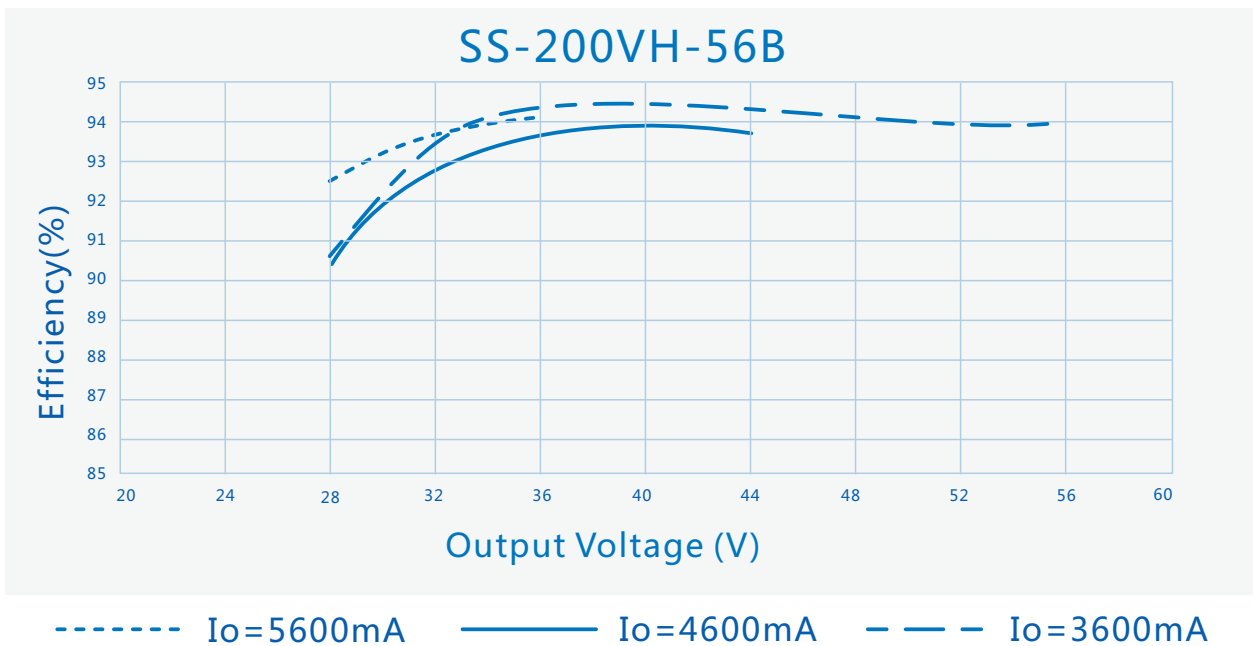

# SS-200VH Series LED Driver

## Performance Curves:

Efficiency Vs. O/P Voltage ( $V_{in}=277V_{ac}$ )

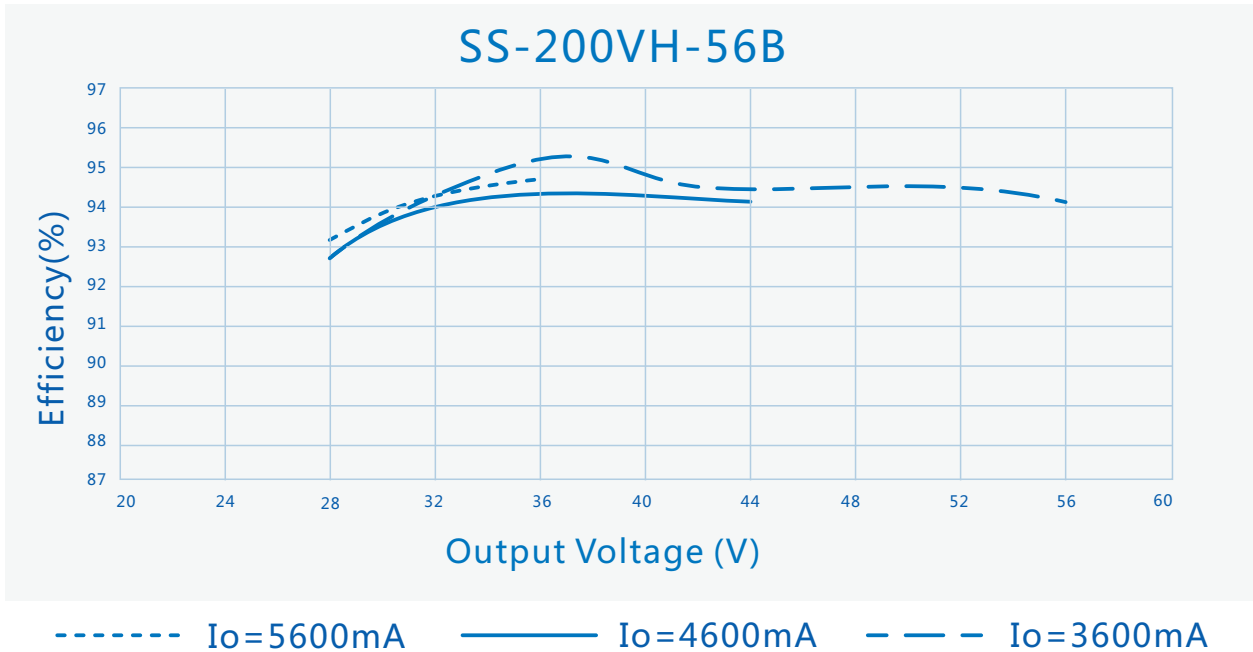

Efficiency Vs. O/P Voltage ( $V_{in}=120V_{ac}$ )

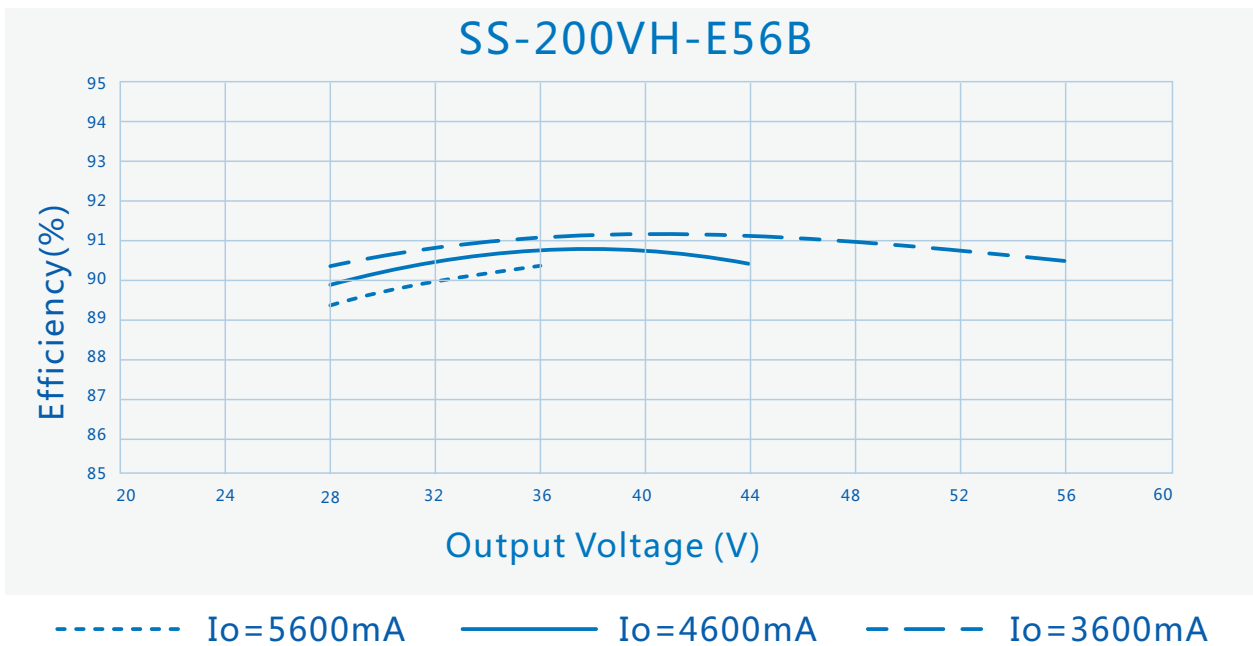

# SS-200VH Series LED Driver

## Performance Curves:

Efficiency Vs. O/P Voltage ( $V_{in}=220V_{ac}$ )

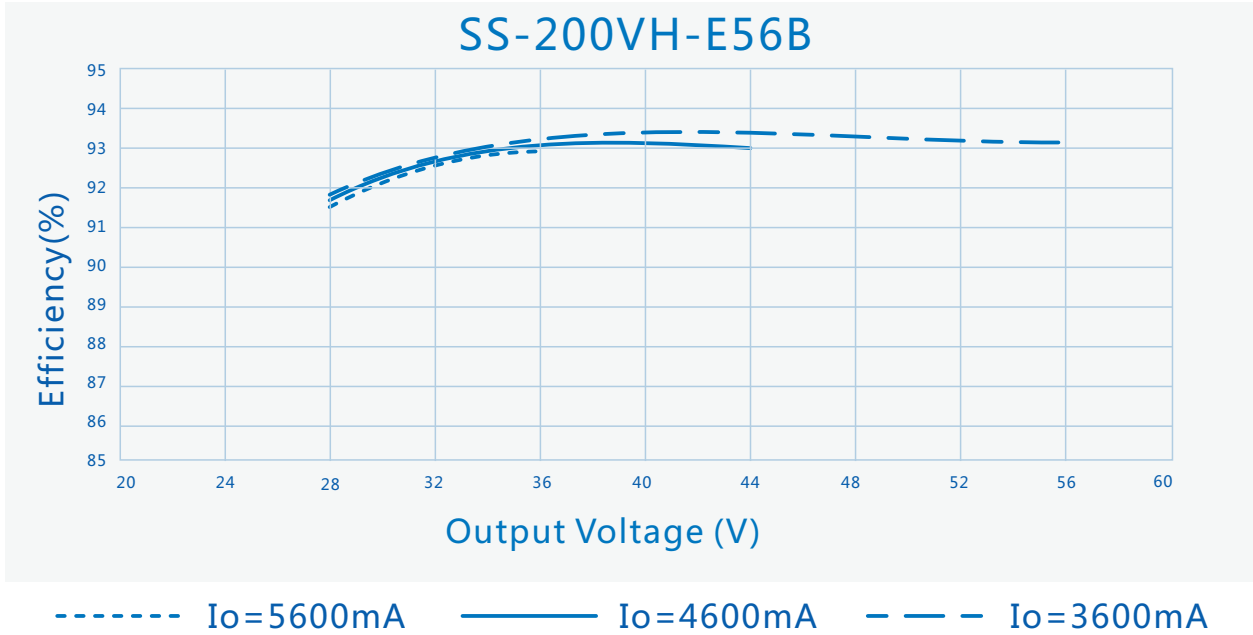

Efficiency Vs. O/P Voltage ( $V_{in}=277V_{ac}$ )

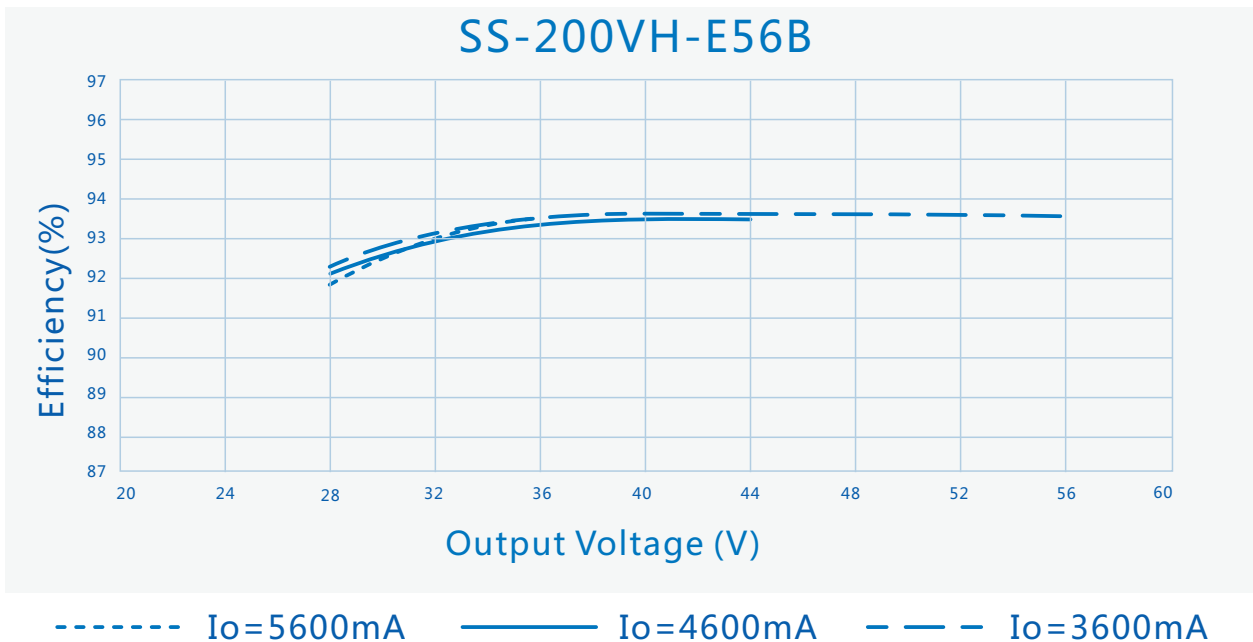

# SS-200VH Series LED Driver

## Performance Curves:

Efficiency Vs. O/P Voltage ( $V_{in}=120Vac$ )

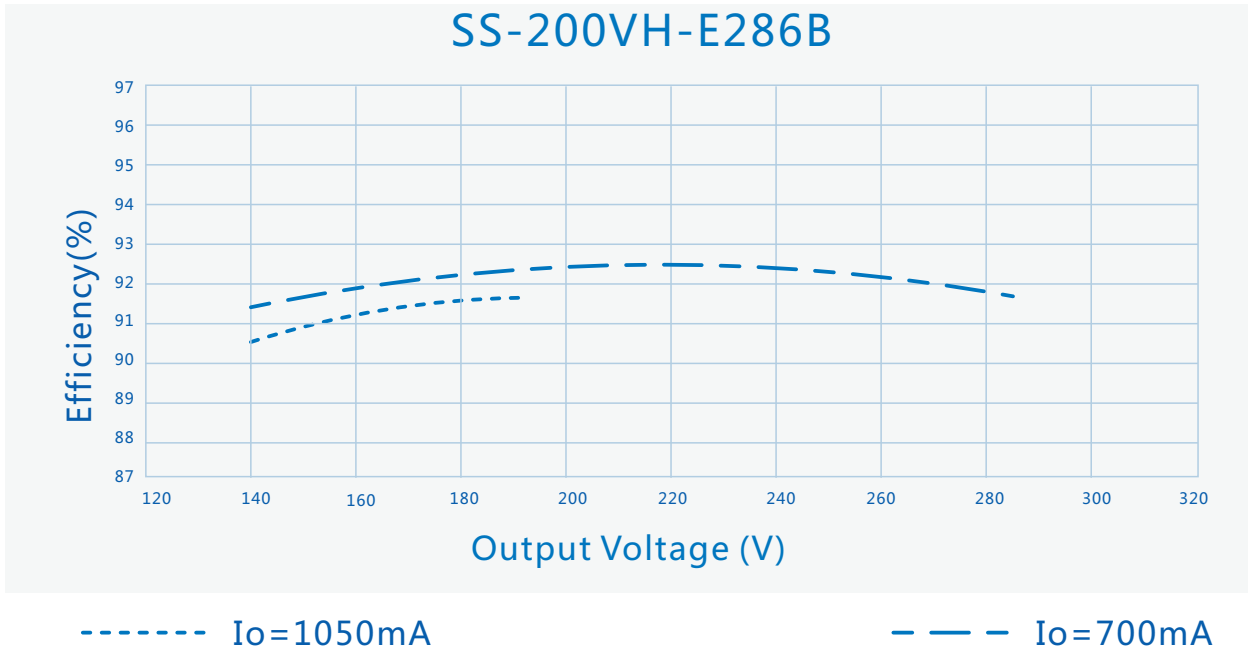

Efficiency Vs. O/P Voltage ( $V_{in}=220Vac$ )

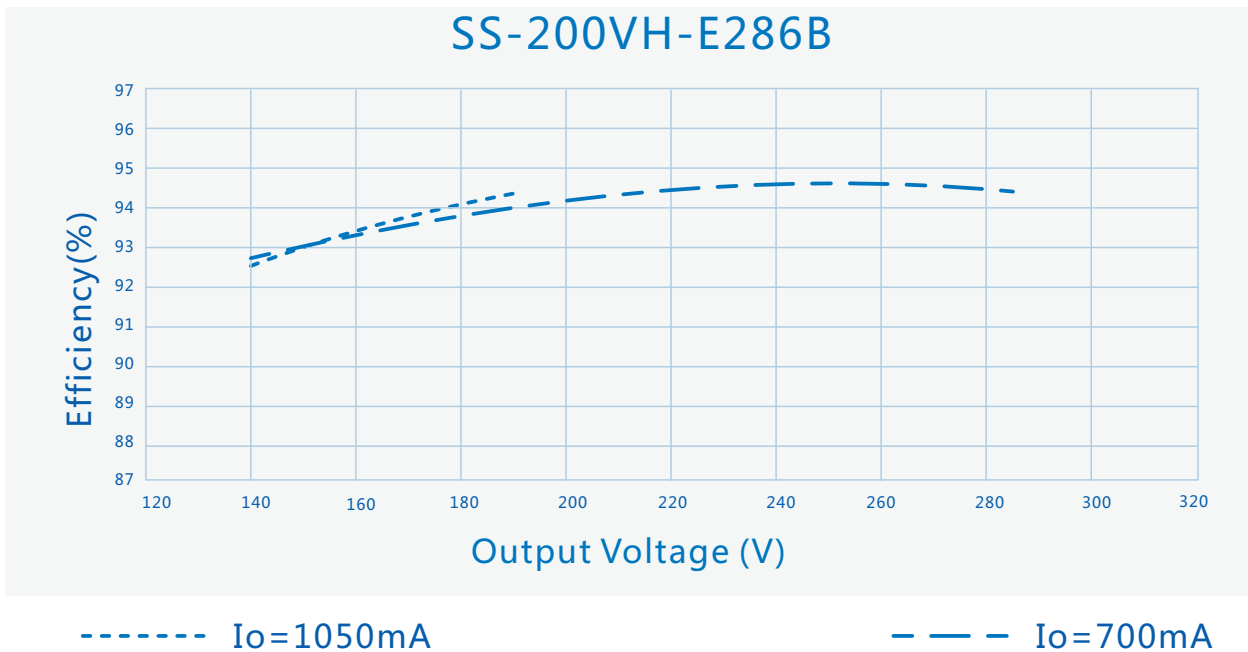

# SS-200VH Series LED Driver

## Performance Curves:

Efficiency Vs. O/P Voltage ( $V_{in}=277V_{ac}$ )

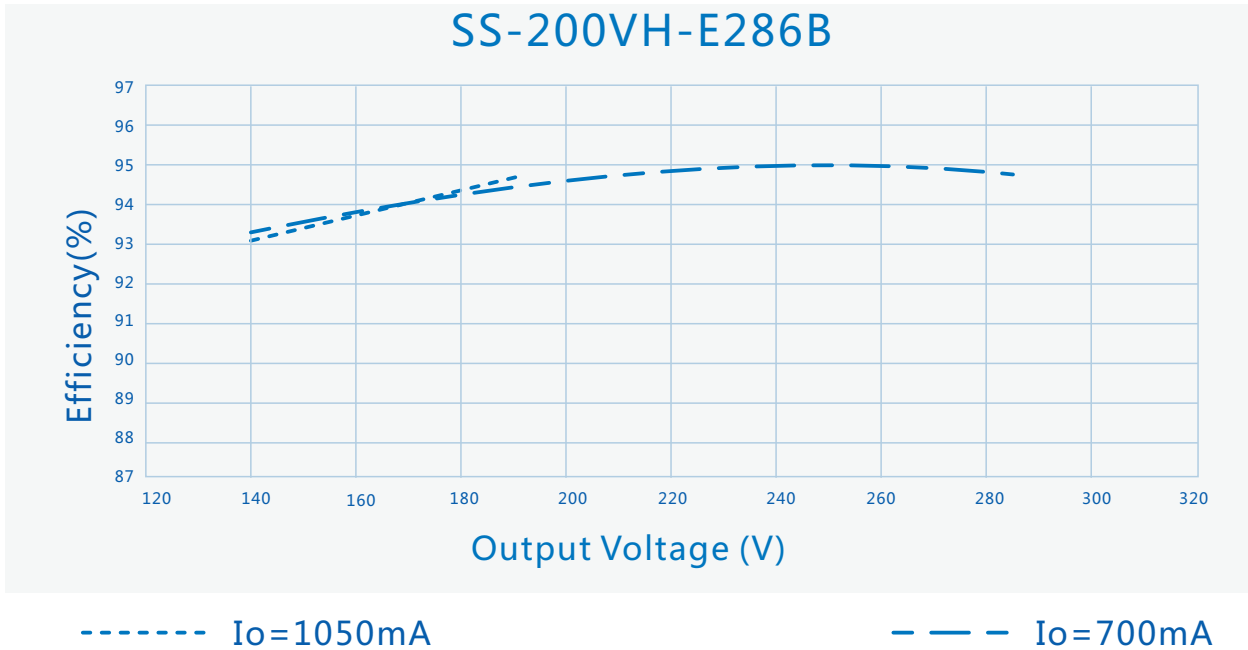



# SS-200VH Series LED Driver

## Performance Curves(SS-200VH):

### Power Factor Vs. O/P Power

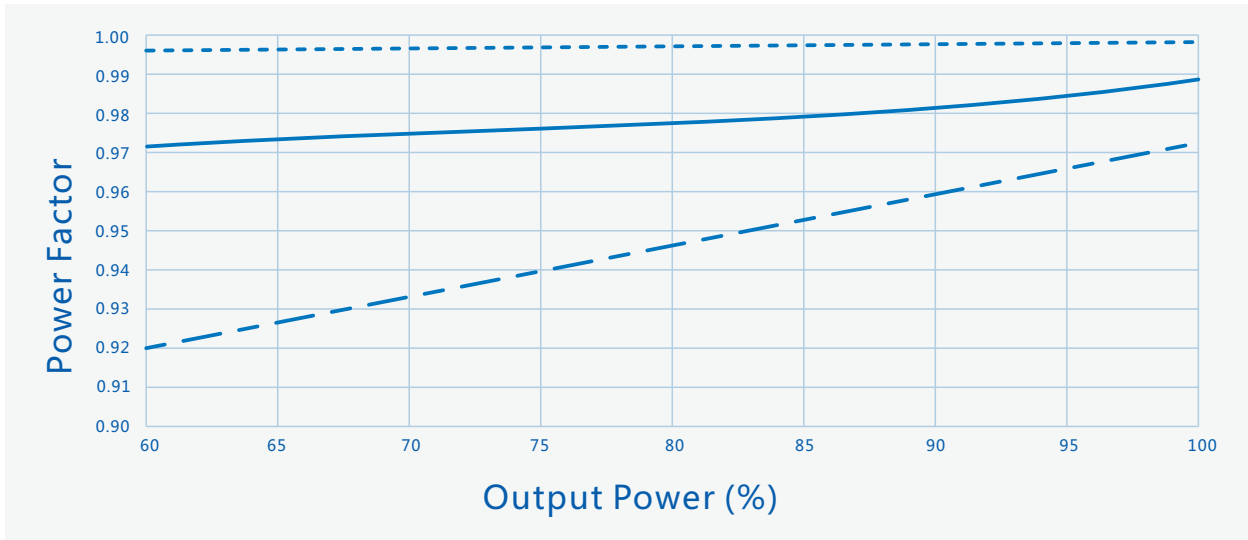

----- Vin=120Vac      ————— Vin=220Vac      - - - - Vin=277Vac

### THD Vs. O/P Power

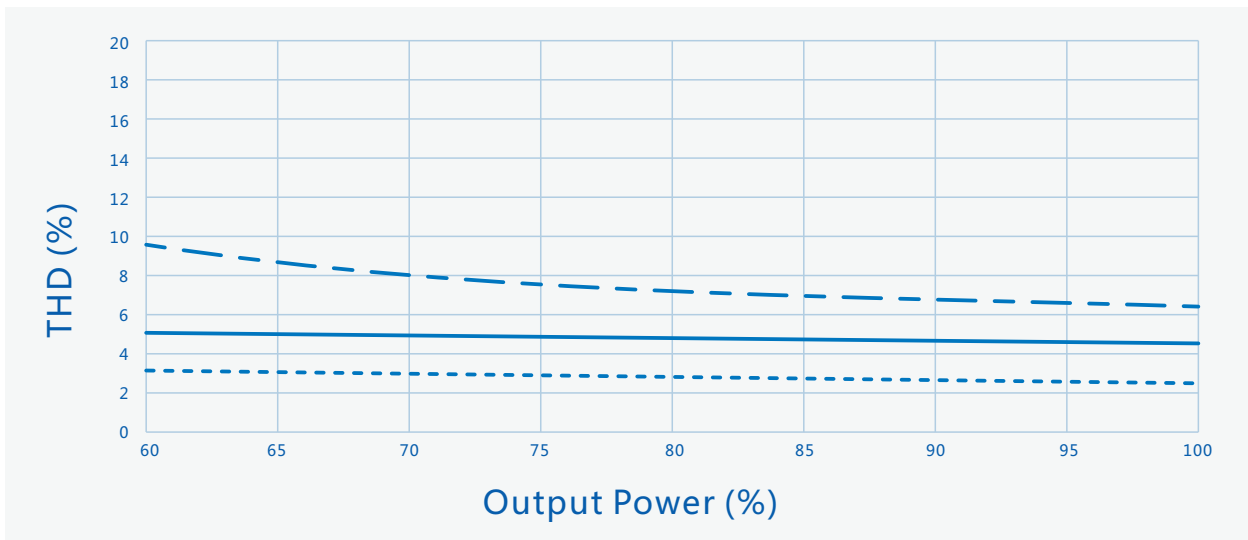

----- Vin=120Vac      ————— Vin=220Vac      - - - - Vin=277Vac

# SS-200VH Series LED Driver

## Performance Curves(SS-200VH-E56B):

Power Factor Vs. O/P Power

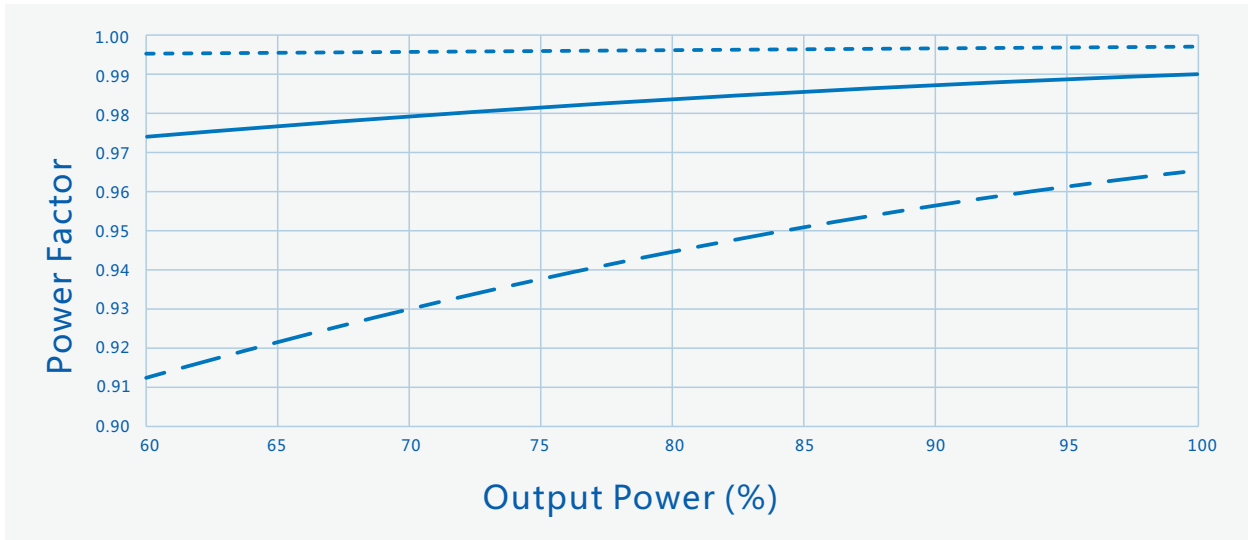

----- Vin=120Vac      ————— Vin=220Vac      - - - - Vin=277Vac

THD Vs. O/P Power

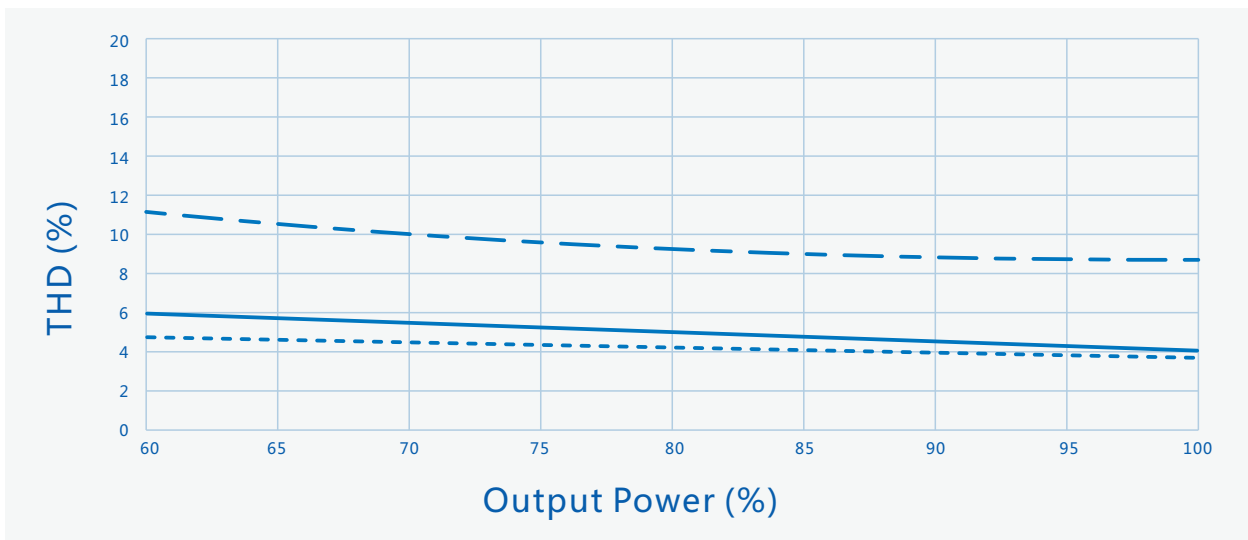

----- Vin=120Vac      ————— Vin=220Vac      - - - - Vin=277Vac

# SS-200VH Series LED Driver

## Performance Curves(SS-200VH-E286B):

### Power Factor Vs. O/P Power

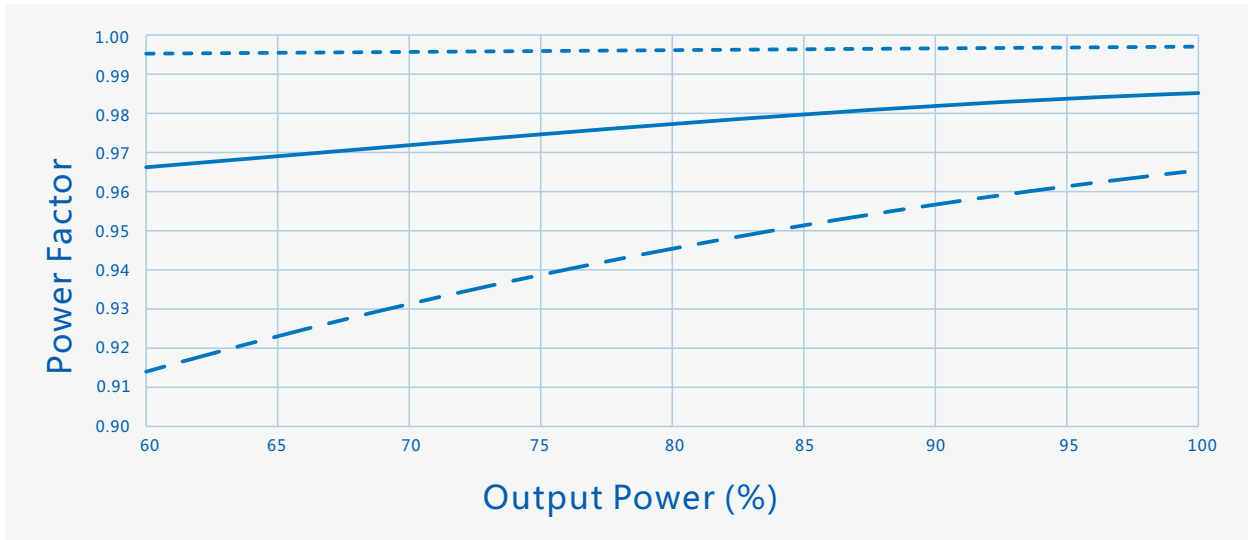

----- Vin=120Vac      ————— Vin=220Vac      - - - - Vin=277Vac

### THD Vs. O/P Power

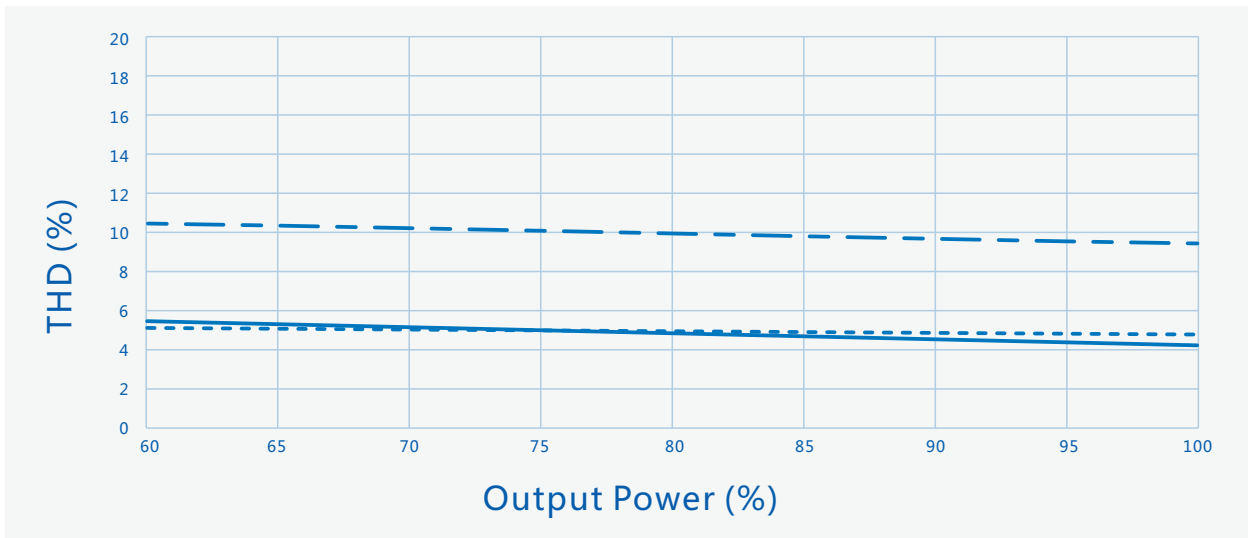

----- Vin=120Vac      ————— Vin=220Vac      - - - - Vin=277Vac

# SS-200VH Series LED Driver

## Performance Curves(SS-200VH):

O/P power Vs. Input Voltage  
(Ta Max.50°C)

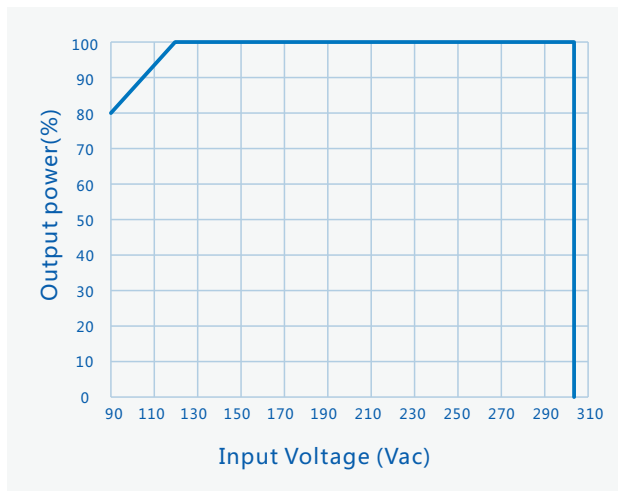

O/P power Vs. Case Temperature

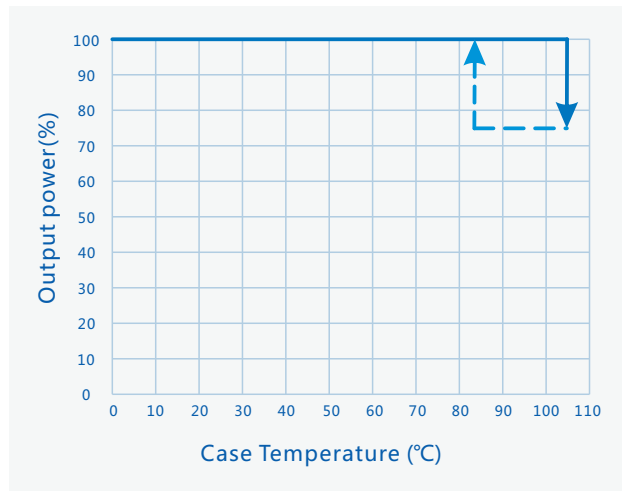

O/P Power Vs. Dimming

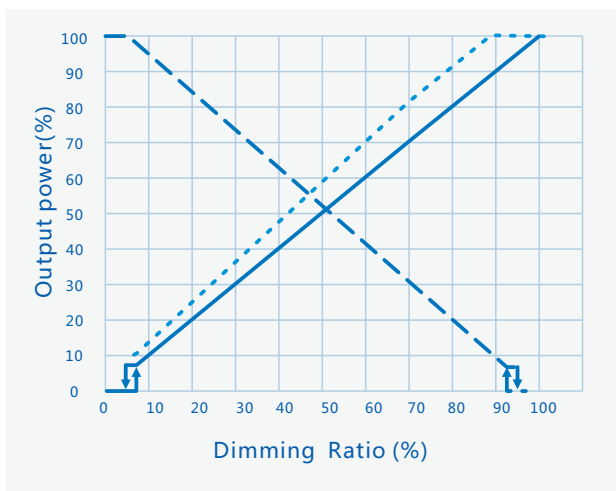

Lifetime Vs. Case Temperature

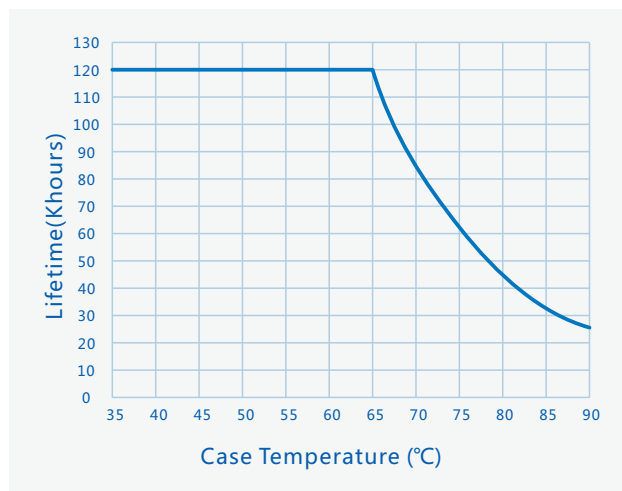

- 0-10V,0-5V,PWM
- - - 10-0V,5-0V
- · · Resistor Dimming(100KΩ)

# SS-200VH Series LED Driver

## Performance Curves(SS-200VH-E):

O/P power Vs. Input Voltage

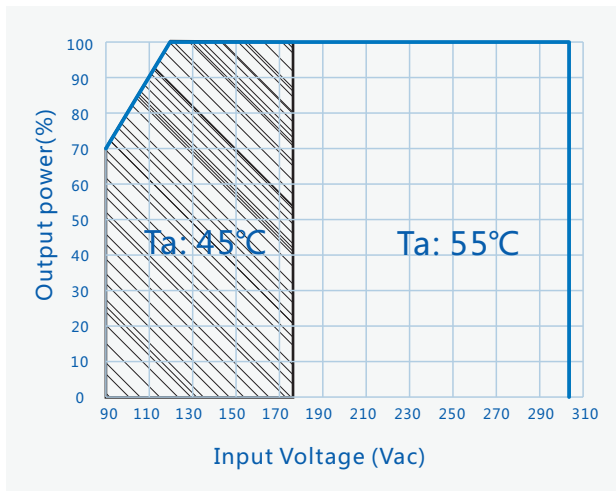

O/P power Vs. Case Temperature

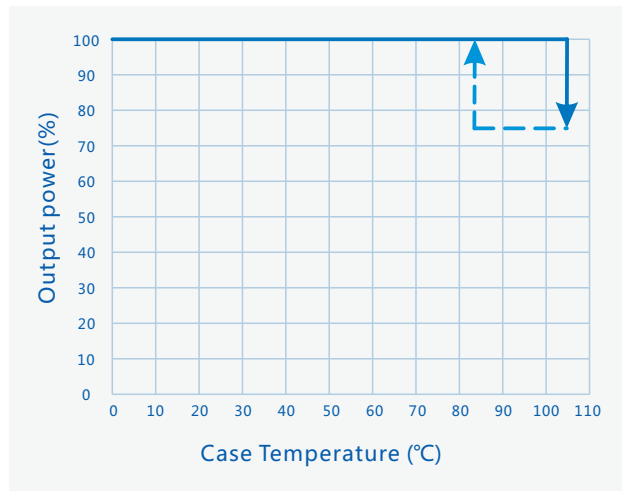

O/P Power Vs. Dimming

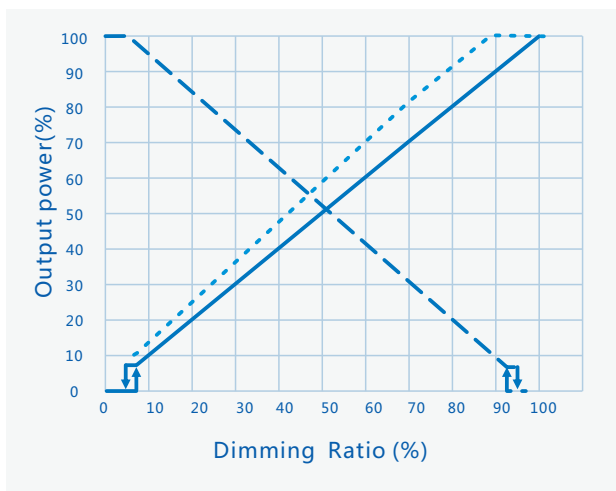

- 0-10V, 0-5V, PWM
- 10-0V, 5-0V
- .... Resistor Dimming(100KΩ)

Lifetime Vs. Case Temperature

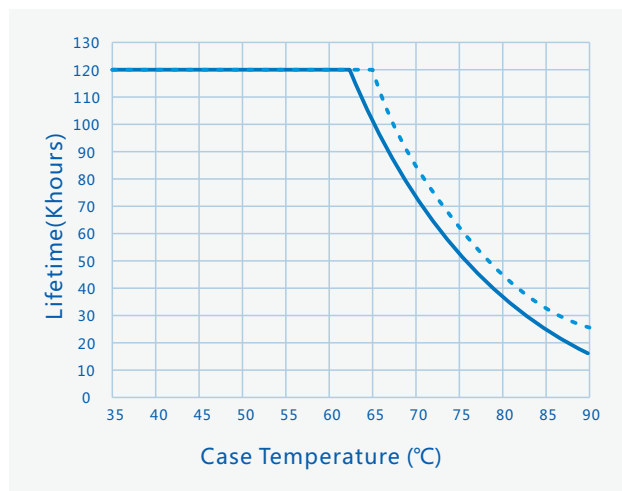

- SS-200VH-E56B
- .... SS-200VH-E286B

# SS-200VH Series LED Driver

## Constant Lumen Output

Constant Lumen Output are design to maintain fixture's stable output lumen by increasing driver's output current within driver's life span to counteract LED lumen degradation.

## Programming connection diagram :

Legacy Timer: Driver's O/P follows the pre-programmed timing curve after turn-on.

Auto-Adjust by Percentage: Driver's O/P will be adjusted by automatically changed dimming curve by the period percentage based on the latest 5 dimming curve.

Auto-Adjust by Mid-point: Driver's O/P will be adjusted by automatically changed dimming curve by mid-point based on the latest 5 dimming curve.

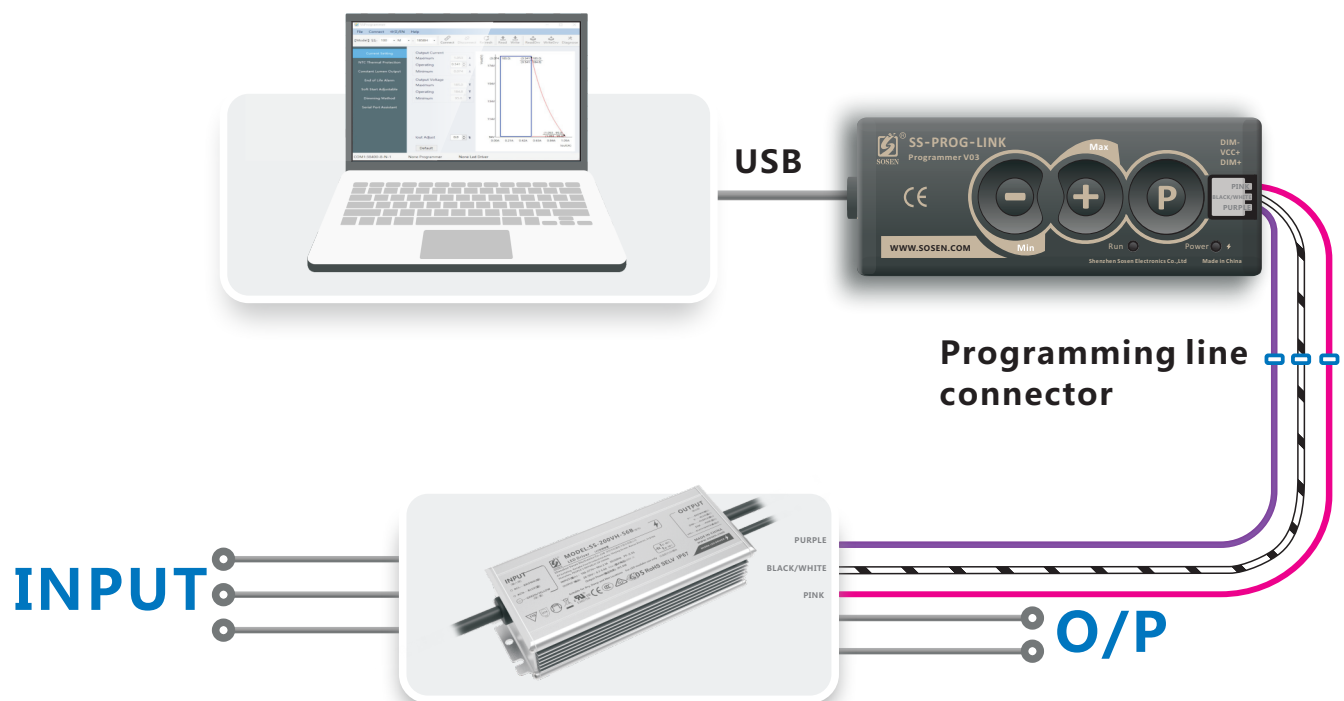

### Note:

For details, please refer to the Sosen SS-PROG-LINK Programmer Manual.

# SS-200VH Series LED Driver

## Mechanical Characteristics(SS-200VH)

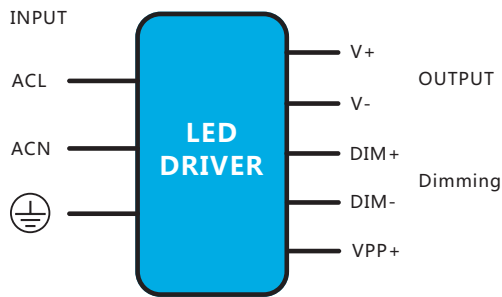

### AC Input Cable(Exposed Length 450±10mm):

UL model: SJTW,3\*18AWG,O.D: 7.8mm,Black:L,White:N,Green:⊕  
 Global model: SJOW,3\*17AWG,O.D: 8.0mm,Brown:L,Blue:N,Yellow/Green:⊕

### DC O/P Cable(Exposed Length 250±10mm):

UL model: SJTW,2\*18AW,O.D: 7.3mm,Red:V+ , Black:V-  
 Global model: SJOW,2\*17AWG,O.D: 7.7mm,Brown:V+ , Blue:V-

### DIM Cable(Exposed Length 220±10mm):

UL/EU model: STYLE 21996 ,3\*22AWG , O.D: 4.9mm , Purple : DIM+ ,  
 Pink: DIM- ,Black/White: VPP+

Name Description	Standard Code	mm(In.)
Case Length	L3	163(6.42)
Case Width	W1	66(2.6)
Case Height	H	37(1.46)
Overall Length	L1	180(7.09)
Mounting Hole Length	L2	171(6.73)
Mounting Hole Width	W2	32(1.26)
TC Point Position	X	60(2.36)
TC point Position	Y	33(1.3)

Note :

- Please follow the "LED Driver User Manual" obtained from SOSEN's official website for assembly.
- AC Input Cable,DC O/P Cable,DIM/AUX Power/Programming Cable:  
 Peeled length of cable:43±5mm, Tinned length of wire:10±2mm

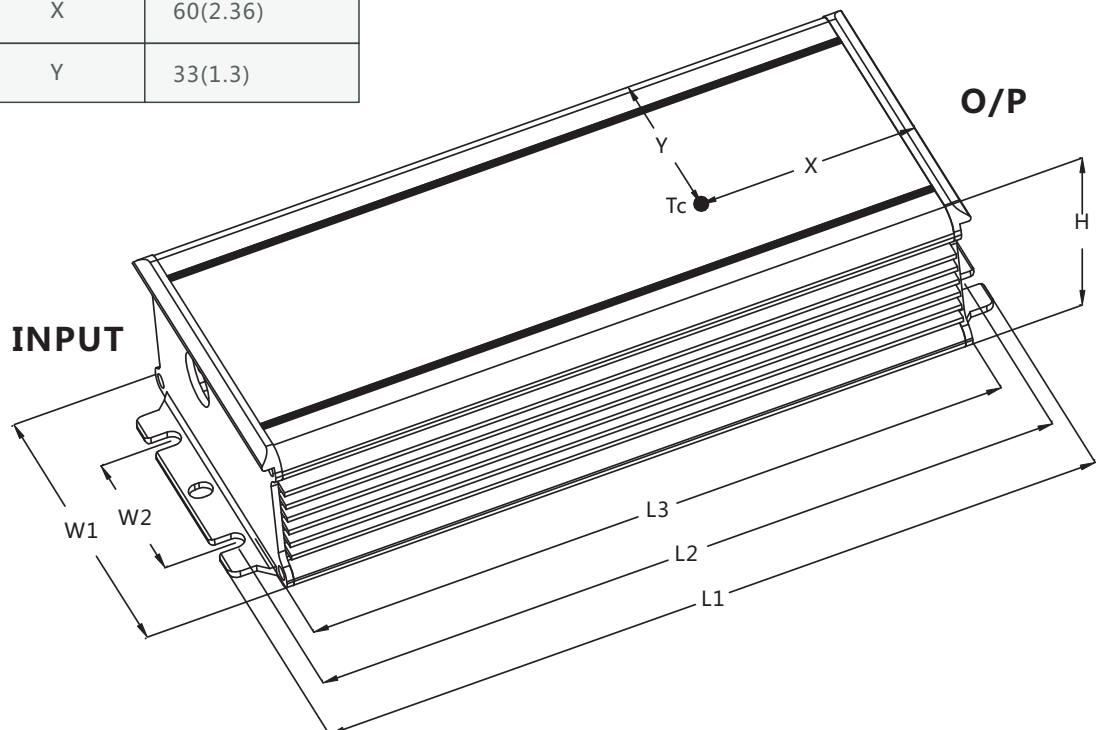

# SS-200VH Series LED Driver

## Mechanical Characteristics(SS-200VH-E)

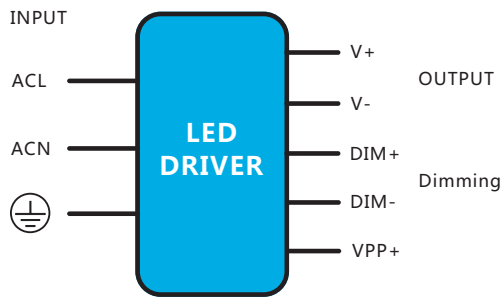

### AC Input Cable(Exposed Length 450±10mm):

UL model: SJTW,3\*18AWG,O.D: 7.8mm,Black:L,White:N,Green:⊕  
 Global model: SJOW,3\*17AWG,O.D: 8.0mm,Brown:L,Blue:N,Yellow/Green:⊕

### DC O/P Cable(Exposed Length 250±10mm):

UL model: SJTW,2\*18AW,O.D: 7.3mm,Red:V+ , Black:V-  
 Global model: SJOW,2\*17AWG,O.D: 7.7mm,Brown:V+ , Blue:V-

### DIM Cable(Exposed Length 220±10mm):

UL/EU model: STYLE 21996 ,3\*22AWG , O.D: 4.9mm , Purple : DIM+ ,  
 Pink: DIM- ,Black/White: VPP+

Name Description	Standard Code	mm(In.)
Case Length	L3	148(5.83)
Case Width	W1	66(2.6)
Case Height	H	37(1.46)
Overall Length	L1	165(6.5)
Mounting Hole Length	L2	156(6.14)
Mounting Hole Width	W2	32(1.26)
TC Point Position	X	50(1.97)
TC Point Position	Y	35(1.38)

Note :

- Please follow the "LED Driver User Manual" obtained from SOSEN's official website for assembly.
- AC Input Cable,DC O/P Cable,DIM/AUX Power/Programming Cable:  
 Peeled length of cable:43±5mm, Tinned length of wire:10±2mm

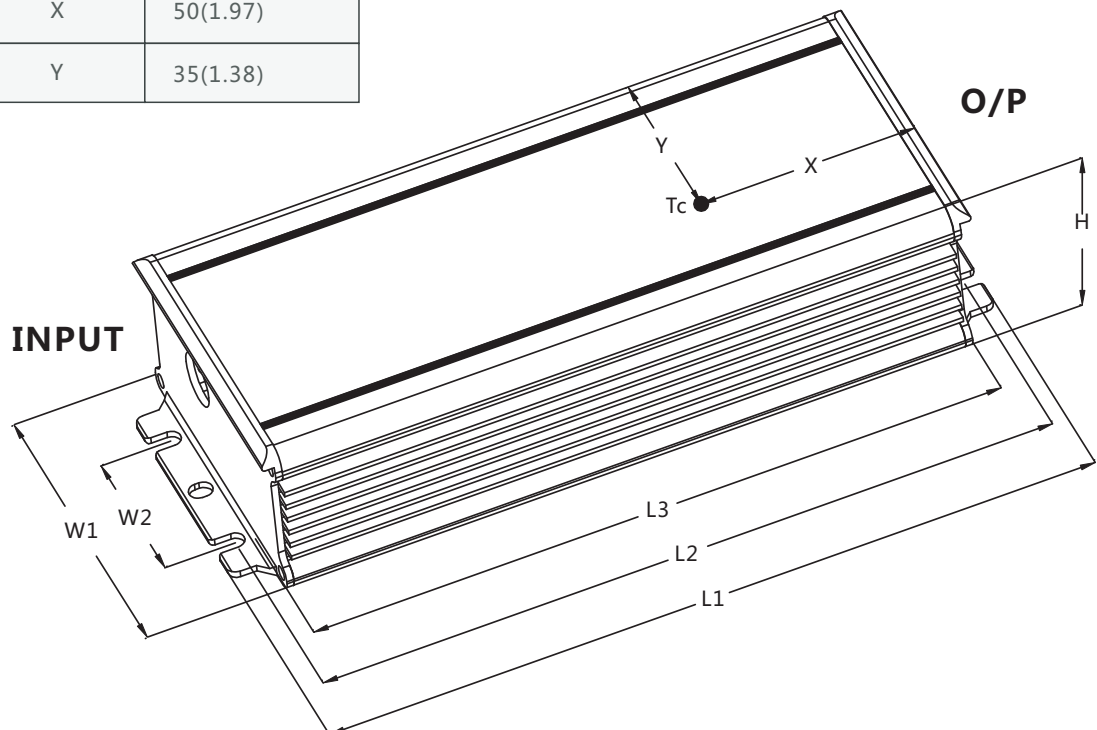



# SS-200VH Series LED Driver



## Assembly Tips

1. Please take isolation and waterproof measures if the dimming cable is not in use.

## Package(SS-200VH)

- Outside carton dimension: L×W×H =495mm×385mm×162mm;
- 14PCS/Carton;
- Net weight/Piece: 0.81kg;Gross weight/Carton: 12.8kg;
- Please refer to the product name, model number, manufacturer identification, QC PASS, manufacturing date on the package.

## Package(SS-200VH-E)

- Outside carton dimension: L×W×H =495mm×385mm×162mm;
- 14PCS/Carton;
- Net weight/Piece: 0.75kg;Gross weight/Carton: 12kg;
- Please refer to the product name, model number, manufacturer identification, QC PASS, manufacturing date on the package.

## Transportation

Packaging is designed suitable for transportation by trucks, vessels and flights. The products should be avoided direct sunlight and rain, loaded/unloaded with caution.

## Storage

The product storage meets the standard of the GB 3873 - 83.  
Products should be rechecked if stored for over 1 year before assembly.

## RoHS

Products comply with RoHS Directive (2011/65/EU) and amendment 2015/863/EU.

## Revision History

Version	Description of Update	Updated Date	Remark
V00	Original release	2020/09/01	
V01	Update Certification	2020/12/23	
V02	Update DIM Cable Color	2021/09/02	
V03	Add SS-200VH-E56B Model	2022/03/08	
V04	Add SS-150VH-E215B Model	2022/05/08	

