



## Datasheet

# Xitanium Highbay LED Drivers Dimmable (1-10V) Independent

## Xitanium Dim 150W 1.05A 1-10V 230V I165C

LED-based light sources are an excellent solution for highbay industrial applications. They are long-lasting and require low maintenance. However, to get the best out of the LEDs, these light sources require highly reliable and efficient LED Drivers. Philips Xitanium Dimmable (1-10V) LED Outdoor Drivers are specifically designed to deliver reliable performance and protection while meeting the strict performance, approbation and application requirements.

### Benefits

- Reliable and robust design, capable of withstanding harsh operating conditions
- Backed by a 5 year warranty from a company you can trust
- Consistent waterproof performance throughout the lifecycle
- Easy to design-in, based on superior thermal management and compact size

### Features

- Proven robustness and reliable electronic driver design
- Achieving highest efficiencies based on advanced technology
- Extremely long lifetime, fitting with highbay industrial applications
- Independent/IP67 rated
- Dimmable through 1-10V interface
- Suitable for IEC insulation Class I systems
- Authorized certificates: CE, ENEC, CB and CCC

### Application

- Highbay industrial lighting
- Warehouse lighting
- Big-box retail store lighting

## Electrical input data

Specification item	Value	Unit	Condition
Nominal input voltage	220...240	V <sub>ac</sub>	performance range
Nominal input frequency	50...60	Hz	
Nominal input current	0.76	A	@230V @ full load
Max. input current	0.83	A	@ minimum input voltage AC
Input voltage	230	V <sub>ac</sub>	
Nominal input power	169	W	@230V @ full load
Power factor	≥ 0.98		@ full load. See graph.
Total harmonic distortion	≤ 20	%	@ full load. See graph.
Efficiency	91	%	@230V @ full load
Input voltage AC	198...264	V <sub>ac</sub>	Operational range
Input frequency AC	45...66	Hz	Operational range
Isolation Input to Output	Basic		

## Electrical output data

Specification item	Value	Unit	Condition
Regulation method	Constant Current		
Output voltage	71...142	V <sub>dc</sub>	
Output current	1.05	A	Full output current setting
Output current min dimming	105	mA	
Output current tolerance	± 5	%	
Output current ripple LF	≤ 15	%	Ripple = peak / average
Output current ripple HF	≤ 15	%	
Output power	7...150	W	Full output

## Electrical data controls input

Specification item	Value	Unit	Condition
Control method	1-10V		Output current amplitude dimming, 1-10V acc. IEC60929
Galvanic Isolation	Basic		

## Logistical data

Specification item	Value
Product name	Xitanium Dim 150W 1.05A 1-10V 230V I165C
Order code	
Logistic code 12NC	9290 014 07880
EAN3	
Pieces per box	12

## Wiring & Connections

Specification item	Value	Unit	Condition
Input wire cross-section	0.33...0.75	mm <sup>2</sup>	stranded wire
	18...22	AWG	stranded wire
Input wire strip length	7.5...8.5	mm	
Output wire cross-section	0.33...0.75	mm <sup>2</sup>	stranded wire
	18...22	AWG	stranded wire
Output wire strip length	7.5...8.5	mm	

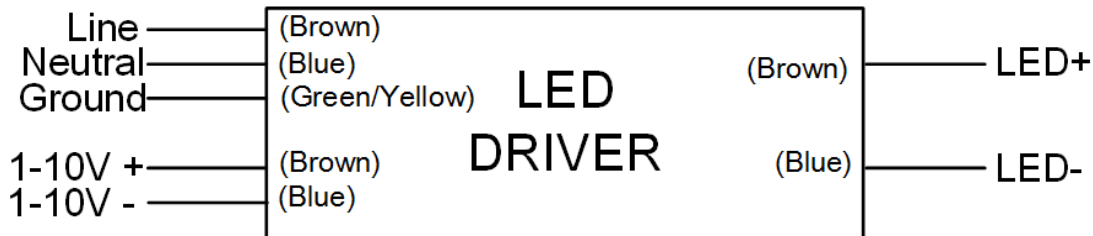

## Insulation

Insulation	Mains	LED	1-10V
Mains		Basic	Basic
LED	Basic		Basic
1-10V	Basic	Basic	

## Dimensions and weight

Specification item	Value	Unit	Condition
Length (A1)	165	mm	
Width (B1)	65.1	mm	
Width (B2)	12	mm	
Height (C1)	73	mm	
Fixing hole diameter (D1)	5.4	mm	
Fixing hole distance (A2)	125	mm	

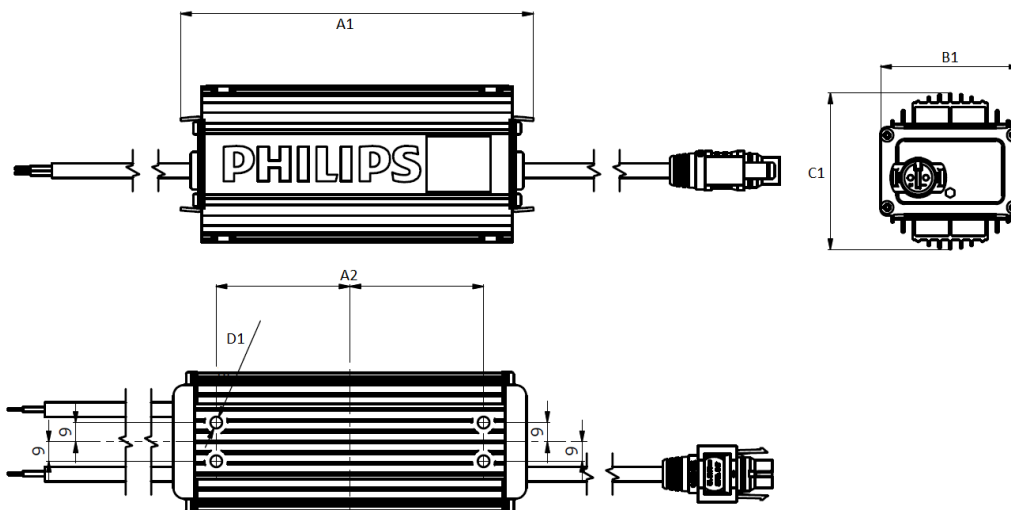

## Operational temperatures and humidity

Specification item	Value	Unit	Condition
Ambient temperature	-40...+65	°C	Higher ambient temperature allowed as long as Tcase-max is not exceeded.
Starting Ambient temperature	-40...+65	°C	
Tcase-max	85	°C	Maximum temperature measured at T <sub>case</sub> -point
Tcase-life		°C	Measured at T <sub>case</sub> -point
Maximum housing temperature	90	°C	In case of a failure
Relative humidity	10...90	%	Non-condensing

## Storage temperature and humidity

Specification item	Value	Unit	Condition
Ambient temperature	-40...+85	°C	
Relative humidity	5...95	%	Non-condensing

## Lifetime

Specification item	Value	Unit	Condition
Driver lifetime	50,000	hours	Measured temperature at T <sub>case</sub> -point is T <sub>case</sub> -life. Maximum failures = 10%

## Programmable features

Specification item	Value	Remark	Condition
Set output current (AOC)	No	See Design-in guide.	Default output current: = 1050 mA

## Features

Specification item	Value	Remark	Condition
Open load protection	Yes		Automatic recovering
Short circuit protection	Yes		Automatic recovering
Over power protection	Yes		Automatic recovering
Hot wiring	No		
Suitable for fixtures with protection class	I		per IEC60598
Over temperature protection driver	Yes		Automatic recovering

## Certificates and standards

Specification item	Value
Approval marks	CB / CCC / CE / ENEC
Ingress Protection classification	67

## Inrush current

Specification item	Value	Unit	Condition
Inrush current $I_{peak}$		A	Input voltage 230V
Inrush current $T_{width}$		$\mu$ s	Input voltage 230V, measured at 50% $I_{peak}$
Drivers / MCB 16A type B		pcs	

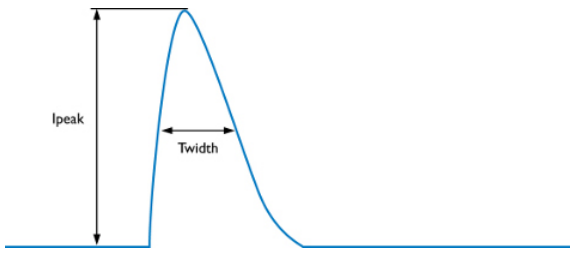

MCB	Rating	Relative number of LED drivers
B	10A	63%
B	13A	81%
B	16A	100% (stated in datasheet)
B	20A	125%
B	25A	156%
C	10A	104%
C	13A	135%
C	16A	170%
C	20A	208%
C	25A	260%

## Driver touch current

Specification item	Value	Unit	Condition
Typical touch current	< 0.6	mA peak	Acc. IEC61347-1. LED module contribution not included

## Surge immunity

Specification item	Value	Unit	Condition
Mains surge immunity (diff. mode)	4	kV	Acc. IEC61000-4-5. 2 Ohm, 1.2/50us, 8/20us
Mains surge immunity (comm. mode)	6	kV	Acc. IEC61000-4-5. 12 Ohm 1.2/50us,8/20us
Control surge immunity (diff. mode)	0.5	kV	Acc. IEC61000-4-5. 2 $\Omega$ , 1.2/50us, 8/20us
Control surge immunity (comm. mode)	6	kV	Acc. IEC61000-4-5. 12 $\Omega$ , 1.2/50us, 8/20us

## Graphs

### Operating window

---

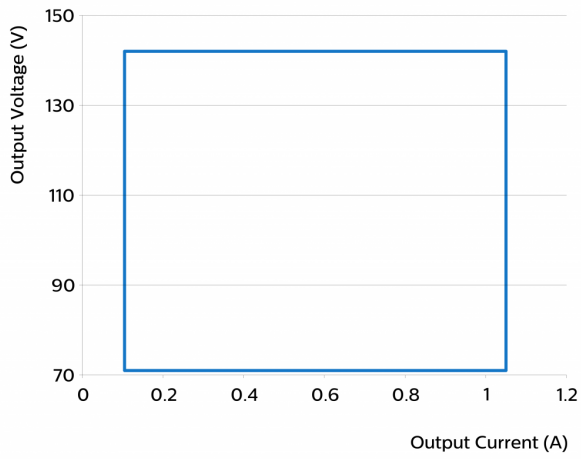

### Power factor versus output power

---

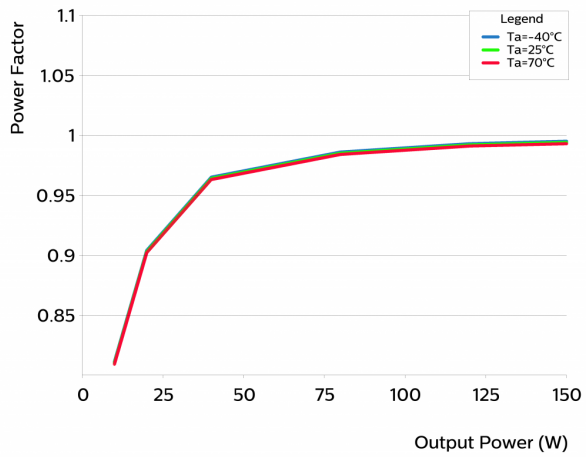

## Efficiency versus output power

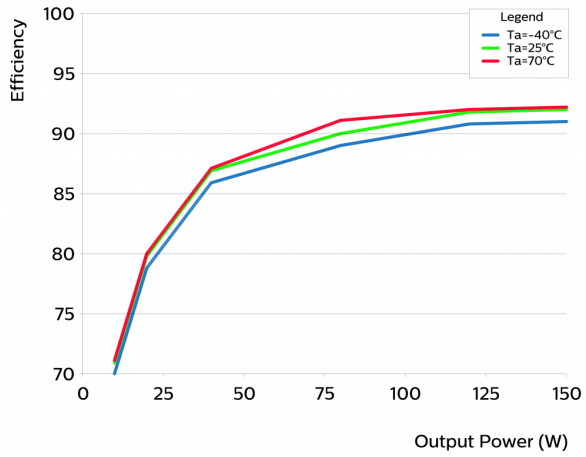

## THD versus output power

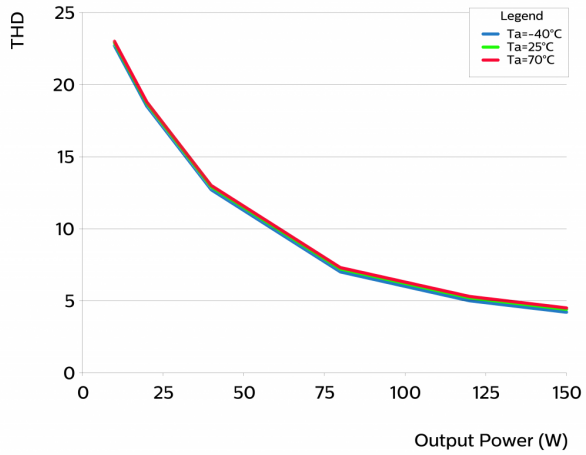

©2016 Philips Lighting B.V.

All rights reserved. Reproduction in whole or in part is prohibited without the prior written consent of the copyright owner. The information presented in this document does not form part of any quotation or contract, is believed to be accurate and reliable and may be changed without notice. No liability will be accepted by the publisher for any consequence of its use. Publication thereof does not convey nor imply any license under patent- or other industrial or intellectual property rights. Data subject to change.

Date of release: December 19, 2016

[www.philips.com/technology](http://www.philips.com/technology)