

XLamp® XP-G2 LEDs

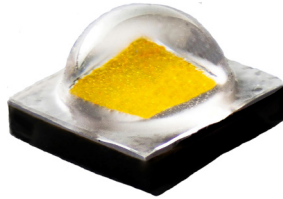

XP-G2 Standard LED

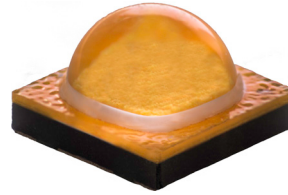

XP-G2 High Efficacy LED

PRODUCT DESCRIPTION

The original XLamp® XP-G2 LED pioneered a broad set of LED applications for the industry, including outdoor and area lighting, and has since served as a preferred choice by manufacturers that require advanced output, efficacy and optical control. The compact and proven 3.45-mm XP platform has an excellent ecosystem of optics and system solutions available, enabling lighting manufacturers to simplify their design process and shorten time to market.

XP-G2 LEDs are now available in two different White versions: Standard and High Efficacy (HE). XP-G2 Standard is the same breakthrough product that enabled a broad set of new LED applications for ceramic high-power LEDs.

The new High Efficacy version extends this legacy with a drop-in upgrade for existing designs optimized around XP-G2 LEDs. XP-G2 HE LEDs leverage Cree LED's latest high-power chip technology to deliver 25 percent more light output via a higher maximum current of 2000 mA and higher efficacy.

FEATURES

- Available in white, outdoor white and 80-, 85- and 90-CRI white
- ANSI-compatible chromaticity bins
- Broadcast color option at 5700 K
- Binned at 85 °C
- Maximum drive current: Standard: 1500 mA, HE: 2000 mA
- Low thermal resistance: 1.4 °C/W
- Wide viewing angle: Standard: 120°, HE: 125°
- Unlimited floor life at ≤ 30 °C/85% RH
- Reflow solderable - JEDEC J-STD-020C
- Electrically neutral thermal path
- RoHS and REACH compliant
- UL® recognized component (E349212)



Cree LED / 4001 E. Hwy. 54, Suite 2000 / Durham, NC 27709 USA / +1.919.313.5330 / www.cree-led.com

TABLE OF CONTENTS

| | |
|---|----|
| Characteristics | 3 |
| Order Codes Suggested for New Designs - High Efficacy..... | 4 |
| Order Codes Suggested for New Designs - Standard..... | 10 |
| Flux Characteristics - Broadcast Order Codes and Bins..... | 14 |
| Relative Spectral Power Distribution | 15 |
| Relative Flux vs. Junction Temperature..... | 15 |
| Electrical Characteristics - High Efficacy..... | 16 |
| Electrical Characteristics - Standard | 16 |
| Relative Flux vs. Current - High Efficacy..... | 17 |
| Relative Flux vs. Current - Standard | 17 |
| Relative Chromaticity vs Current and Temperature - High Efficacy..... | 18 |
| Relative Chromaticity vs Current and Temperature - Standard..... | 19 |
| Typical Spatial Distribution - High Efficacy..... | 20 |
| Typical Spatial Distribution - Standard | 20 |
| Thermal Design - High Efficacy..... | 21 |
| Thermal Design - Standard..... | 21 |
| Performance Groups – Luminous Flux..... | 22 |
| Performance Groups – Chromaticity..... | 23 |
| Standard Cool White Kits Plotted on ANSI Standard Chromaticity Regions..... | 26 |
| Standard Warm and Neutral White Kits Plotted on ANSI Standard Chromaticity Regions..... | 28 |
| Standard Chromaticity Kits | 30 |
| Bin and Order Code Formats..... | 31 |
| Reflow Soldering Characteristics..... | 32 |
| Notes | 33 |
| Mechanical Dimensions | 35 |
| Tape and Reel..... | 37 |
| Packaging..... | 39 |
| Appendix - Order Codes Not For New Designs | 40 |

CHARACTERISTICS

| Characteristics | Unit | Minimum | Typical | Maximum |
|---|---------|---------|----------|---------|
| Thermal resistance, junction to solder point - High Efficacy ^o | °C/W | | 1.4 | |
| Thermal resistance, junction to solder point - Standard ^o | °C/W | | 1.4 | |
| Viewing angle (FWHM) - High Efficacy | degrees | | 125 | |
| Viewing angle (FWHM) - Standard | degrees | | 120 | |
| Temperature coefficient of voltage - High Efficacy | mV/°C | | -1.3 | |
| Temperature coefficient of voltage - Standard | mV/°C | | -1.3 | |
| ESD withstand voltage (HBM per Mil-Std-883D) | | | Class 3B | |
| DC forward current - High Efficacy | mA | | | 2000 |
| DC forward current - Standard | mA | | | 1500 |
| Reverse voltage | V | | | 1 |
| Forward voltage (@ 350 mA, 85 °C) - High Efficacy | V | | 2.70 | 2.90 |
| Forward voltage (@ 350 mA, 85 °C) - Standard | V | | 2.72 | 3.1 |
| Forward voltage (@ 700 mA, 85 °C) - High Efficacy | V | | 2.80 | |
| Forward voltage (@ 700 mA, 85 °C) - Standard | V | | 2.83 | |
| Forward voltage (@ 1000 mA, 85 °C) - High Efficacy | V | | 2.87 | |
| Forward voltage (@ 1000 mA, 85 °C) - Standard | V | | 2.90 | |
| Forward voltage (@ 1500 mA, 85 °C) - High Efficacy | V | | 2.97 | |
| Forward voltage (@ 1500 mA, 85 °C) - Standard | V | | 3.02 | |
| LED junction temperature | °C | | | 150 |

Note:

- ◇ Thermal resistance measurement was performed per the JEDEC JESD51-14 standard. See the [Thermal Resistance Measurement application note](#) for more details.

ORDER CODES SUGGESTED FOR NEW DESIGNS - HIGH EFFICACY ($T_j = 85\text{ }^\circ\text{C}$)

The following table provides order codes for XLamp High-Efficacy XP-G2 LEDs. For a complete description of the order code nomenclature, please see the Bin and Order Code Formats section (page 31). For definitions of the chromaticity kits, please see the Standard Chromaticity Kits section (page 30).

| Chromaticity | | Minimum Luminous Flux (lm) @ 350 mA | | | Order Codes | | |
|--------------|--------|-------------------------------------|-------------------|--------------------|----------------------|----------------------|----------------------|
| Kit | CCT | Code | Flux (lm) @ 85 °C | Flux (lm) @ 25 °C* | 70 CRI Minimum | 80 CRI Minimum | 90 CRI Minimum |
| DT | 7000 K | S5 | 172 | 189 | XPGBWT-BE-0000-00MDT | | |
| | | S4 | 164 | 180 | XPGBWT-BE-0000-00LDT | XPGBWT-HE-0000-00LDT | |
| | | S3 | 156 | 171 | XPGBWT-BE-0000-00KDT | XPGBWT-HE-0000-00KDT | |
| | | S2 | 148 | 163 | | XPGBWT-HE-0000-00JDT | |
| E1 | 6500 K | S6 | 180 | 198 | XPGBWT-BE-0000-00NE1 | | |
| | | S5 | 172 | 189 | XPGBWT-BE-0000-00ME1 | | |
| | | S4 | 164 | 180 | XPGBWT-BE-0000-00LE1 | XPGBWT-HE-0000-00LE1 | |
| | | S3 | 156 | 171 | XPGBWT-BE-0000-00KE1 | XPGBWT-HE-0000-00KE1 | |
| | | S2 | 148 | 163 | | XPGBWT-HE-0000-00JE1 | |
| 51 | 6200 K | S6 | 180 | 198 | XPGBWT-BE-0000-00N51 | | |
| | | S5 | 172 | 189 | XPGBWT-BE-0000-00M51 | | |
| | | S4 | 164 | 180 | XPGBWT-BE-0000-00L51 | XPGBWT-HE-0000-00L51 | |
| | | S3 | 156 | 171 | XPGBWT-BE-0000-00K51 | XPGBWT-HE-0000-00K51 | |
| | | S2 | 148 | 163 | | XPGBWT-HE-0000-00J51 | |
| | | R5 | 139 | 153 | | | XPGBWT-UE-0000-00H51 |
| | | R4 | 130 | 143 | | | XPGBWT-UE-0000-00G51 |
| | | R3 | 122 | 134 | | | XPGBWT-UE-0000-00F51 |
| R2 | 114 | 125 | | | | | |

Notes

- For additional order codes NOT recommended for new designs please see the Appendix section starting on page 40 .
- Cree LED maintains a tolerance of $\pm 7\%$ on flux and power measurements, ± 0.005 on chromaticity (CCx, CCy) measurements and a tolerance of ± 2 on CRI measurements. See the Measurements section (page 33).
- XP-G2 LED order codes specify only a minimum flux bin and not a maximum. Cree LED may ship reels in flux bins higher than the minimum specified by the order code without advance notice. Shipments will always adhere to the chromaticity bin restrictions specified by the order code.
- * Flux values @ 25 °C are calculated and for reference only.

ORDER CODES SUGGESTED FOR NEW DESIGNS - HIGH EFFICACY (T_j = 85 °C) - CONTINUED

| Chromaticity | | Minimum Luminous Flux (lm) @ 350 mA | | | Order Codes | | |
|--------------|--------|--|----------------------|-----------------------|----------------------|----------------------|----------------------|
| Kit | CCT | Code | Flux (lm) @ 85 °C | Flux (lm) @ 25 °C* | 70 CRI Minimum | 80 CRI Minimum | 90 CRI Minimum |
| DV | 6000 K | S6 | 180 | 198 | XPGBWT-BE-0000-00NDV | | |
| | | S5 | 172 | 189 | XPGBWT-BE-0000-00MDV | | |
| | | S4 | 164 | 180 | XPGBWT-BE-0000-00LDV | XPGBWT-HE-0000-00LDV | |
| | | S3 | 156 | 171 | XPGBWT-BE-0000-00KDV | XPGBWT-HE-0000-00KDV | |
| | | S2 | 148 | 163 | | XPGBWT-HE-0000-00JDV | |
| | | R5 | 139 | 153 | | | XPGBWT-UE-0000-00HDV |
| | | R4 | 130 | 143 | | | XPGBWT-UE-0000-00GDV |
| | | R3 | 122 | 134 | | | XPGBWT-UE-0000-00FDV |
| 50 | 6000 K | S6 | 180 | 198 | XPGBWT-BE-0000-00N50 | | |
| | | S5 | 172 | 189 | XPGBWT-BE-0000-00M50 | | |
| | | S4 | 164 | 180 | XPGBWT-BE-0000-00L50 | XPGBWT-HE-0000-00L50 | |
| | | S3 | 156 | 171 | XPGBWT-BE-0000-00K50 | XPGBWT-HE-0000-00K50 | |
| | | S2 | 148 | 163 | | XPGBWT-HE-0000-00J50 | |
| | | R5 | 139 | 153 | | | XPGBWT-UE-0000-00H50 |
| | | R4 | 130 | 143 | | | XPGBWT-UE-0000-00G50 |
| | | R3 | 122 | 134 | | | XPGBWT-UE-0000-00F50 |
| E2 | 5700 K | S6 | 180 | 198 | XPGBWT-BE-0000-00NE2 | | |
| | | S5 | 172 | 189 | XPGBWT-BE-0000-00ME2 | | |
| | | S4 | 164 | 180 | XPGBWT-BE-0000-00LE2 | XPGBWT-HE-0000-00LE2 | |
| | | S3 | 156 | 171 | XPGBWT-BE-0000-00KE2 | XPGBWT-HE-0000-00KE2 | |
| | | S2 | 148 | 163 | | XPGBWT-HE-0000-00JE2 | |
| | | R5 | 139 | 153 | | | XPGBWT-UE-0000-00HE2 |
| | | R4 | 130 | 143 | | | XPGBWT-UE-0000-00GE2 |
| | | R3 | 122 | 134 | | | XPGBWT-UE-0000-00FE2 |

Notes

- For additional order codes NOT recommended for new designs please see the Appendix section starting on page 40 .
- Cree LED maintains a tolerance of ±7% on flux and power measurements, ±0.005 on chromaticity (CCx, CCy) measurements and a tolerance of ±2 on CRI measurements. See the Measurements section (page 33).
- XP-G2 LED order codes specify only a minimum flux bin and not a maximum. Cree LED may ship reels in flux bins higher than the minimum specified by the order code without advance notice. Shipments will always adhere to the chromaticity bin restrictions specified by the order code.
- * Flux values @ 25 °C are calculated and for reference only.

ORDER CODES SUGGESTED FOR NEW DESIGNS - HIGH EFFICACY (T_j = 85 °C) - CONTINUED

| Chromaticity | | Minimum Luminous Flux (lm) @ 350 mA | | | Order Codes | | |
|--------------|--------|-------------------------------------|-------------------|--------------------|----------------------|----------------------|----------------------|
| Kit | CCT | Code | Flux (lm) @ 85 °C | Flux (lm) @ 25 °C* | 70 CRI Minimum | 80 CRI Minimum | 90 CRI Minimum |
| E3 | 5000 K | S6 | 180 | 198 | XPGBWT-BE-0000-00NE3 | | |
| | | S5 | 172 | 189 | XPGBWT-BE-0000-00ME3 | XPGBWT-HE-0000-00ME3 | |
| | | S4 | 164 | 180 | XPGBWT-BE-0000-00LE3 | XPGBWT-HE-0000-00LE3 | |
| | | S3 | 156 | 171 | XPGBWT-BE-0000-00KE3 | XPGBWT-HE-0000-00KE3 | |
| | | S2 | 148 | 163 | | XPGBWT-HE-0000-00JE3 | XPGBWT-UE-0000-00JE3 |
| | | R5 | 139 | 153 | | | XPGBWT-UE-0000-00HE3 |
| | | R4 | 130 | 143 | | | XPGBWT-UE-0000-00GE3 |
| | | R3 | 122 | 134 | | | XPGBWT-UE-0000-00FE3 |
| F4 | 4750 K | S6 | 180 | 198 | XPGBWT-BE-0000-00NF4 | | |
| | | S5 | 172 | 189 | XPGBWT-BE-0000-00MF4 | XPGBWT-HE-0000-00MF4 | |
| | | S4 | 164 | 180 | XPGBWT-BE-0000-00LF4 | XPGBWT-HE-0000-00LF4 | |
| | | S3 | 156 | 171 | XPGBWT-BE-0000-00KF4 | XPGBWT-HE-0000-00KF4 | |
| | | S2 | 148 | 163 | | XPGBWT-HE-0000-00JF4 | XPGBWT-UE-0000-00JF4 |
| | | R5 | 139 | 153 | | | XPGBWT-UE-0000-00HF4 |
| | | R4 | 130 | 143 | | | XPGBWT-UE-0000-00GF4 |
| | | R3 | 122 | 134 | | | XPGBWT-UE-0000-00FF4 |
| E4 | 4500 K | S6 | 180 | 198 | XPGBWT-BE-0000-00NE4 | | |
| | | S5 | 172 | 189 | XPGBWT-BE-0000-00ME4 | | |
| | | S4 | 164 | 180 | XPGBWT-BE-0000-00LE4 | XPGBWT-HE-0000-00LE4 | |
| | | S3 | 156 | 171 | XPGBWT-BE-0000-00KE4 | XPGBWT-HE-0000-00KE4 | |
| | | S2 | 148 | 163 | | XPGBWT-HE-0000-00JE4 | |
| | | R5 | 139 | 153 | | | XPGBWT-UE-0000-00HE4 |
| | | R4 | 130 | 143 | | | XPGBWT-UE-0000-00GE4 |
| | | R3 | 122 | 134 | | | XPGBWT-UE-0000-00FE4 |

Notes

- For additional order codes NOT recommended for new designs please see the Appendix section starting on page 40 .
- Cree LED maintains a tolerance of ±7% on flux and power measurements, ±0.005 on chromaticity (CCx, CCy) measurements and a tolerance of ±2 on CRI measurements. See the Measurements section (page 33).
- XP-G2 LED order codes specify only a minimum flux bin and not a maximum. Cree LED may ship reels in flux bins higher than the minimum specified by the order code without advance notice. Shipments will always adhere to the chromaticity bin restrictions specified by the order code.
- * Flux values @ 25 °C are calculated and for reference only.

ORDER CODES SUGGESTED FOR NEW DESIGNS - HIGH EFFICACY (T_j = 85 °C) - CONTINUED

| Chromaticity | | Minimum Luminous Flux (lm) @ 350 mA | | | Order Codes | | |
|--------------|--------|--|----------------------|-----------------------|----------------------|----------------------|----------------------|
| Kit | CCT | Code | Flux (lm) @ 85 °C | Flux (lm) @ 25 °C* | 70 CRI Minimum | 80 CRI Minimum | 90 CRI Minimum |
| F5 | 4250 K | S6 | 180 | 198 | XPGBWT-BE-0000-00NF5 | | |
| | | S5 | 172 | 189 | XPGBWT-BE-0000-00MF5 | | |
| | | S4 | 164 | 180 | XPGBWT-BE-0000-00LF5 | XPGBWT-HE-0000-00LF5 | |
| | | S3 | 156 | 171 | XPGBWT-BE-0000-00KF5 | XPGBWT-HE-0000-00KF5 | |
| | | S2 | 148 | 163 | | XPGBWT-HE-0000-00JF5 | |
| | | R5 | 139 | 153 | | | XPGBWT-UE-0000-00HF5 |
| | | R4 | 130 | 143 | | | XPGBWT-UE-0000-00GF5 |
| | | R3 | 122 | 134 | | | XPGBWT-UE-0000-00FF5 |
| E5 | 4000 K | S6 | 180 | 198 | XPGBWT-BE-0000-00NE5 | | |
| | | S5 | 172 | 189 | XPGBWT-BE-0000-00ME5 | | |
| | | S4 | 164 | 180 | XPGBWT-BE-0000-00LE5 | XPGBWT-HE-0000-00LE5 | |
| | | S3 | 156 | 171 | XPGBWT-BE-0000-00KE5 | XPGBWT-HE-0000-00KE5 | |
| | | S2 | 148 | 163 | | XPGBWT-HE-0000-00JE5 | |
| | | R5 | 139 | 153 | | | XPGBWT-UE-0000-00HE5 |
| | | R4 | 130 | 143 | | | XPGBWT-UE-0000-00GE5 |
| | | R3 | 122 | 134 | | | XPGBWT-UE-0000-00FE5 |
| F6 | 3750 K | S5 | 172 | 189 | XPGBWT-BE-0000-00MF6 | | |
| | | S4 | 164 | 180 | XPGBWT-BE-0000-00LF6 | XPGBWT-HE-0000-00LF6 | |
| | | S3 | 156 | 171 | XPGBWT-BE-0000-00KF6 | XPGBWT-HE-0000-00KF6 | |
| | | S2 | 148 | 163 | | XPGBWT-HE-0000-00JF6 | |
| | | R5 | 139 | 153 | | | XPGBWT-UE-0000-00HF6 |
| | | R4 | 130 | 143 | | | XPGBWT-UE-0000-00GF6 |
| | | R3 | 122 | 134 | | | XPGBWT-UE-0000-00FF6 |

Notes

- For additional order codes NOT recommended for new designs please see the Appendix section starting on page 40 .
- Cree LED maintains a tolerance of ±7% on flux and power measurements, ±0.005 on chromaticity (CCx, CCy) measurements and a tolerance of ±2 on CRI measurements. See the Measurements section (page 33).
- XP-G2 LED order codes specify only a minimum flux bin and not a maximum. Cree LED may ship reels in flux bins higher than the minimum specified by the order code without advance notice. Shipments will always adhere to the chromaticity bin restrictions specified by the order code.
- * Flux values @ 25 °C are calculated and for reference only.

ORDER CODES SUGGESTED FOR NEW DESIGNS - HIGH EFFICACY (T_J = 85 °C) - CONTINUED

| Chromaticity | | Minimum Luminous Flux (lm) @ 350 mA | | | Order Codes | | |
|--------------|--------|--|----------------------|-----------------------|----------------------|----------------------|----------------------|
| Kit | CCT | Code | Flux (lm) @ 85 °C | Flux (lm) @ 25 °C* | 70 CRI Minimum | 80 CRI Minimum | 90 CRI Minimum |
| E6 | 3500 K | S5 | 172 | 189 | XPGBWT-BE-0000-00ME6 | | |
| | | S4 | 164 | 180 | XPGBWT-BE-0000-00LE6 | XPGBWT-HE-0000-00LE6 | |
| | | S3 | 156 | 171 | XPGBWT-BE-0000-00KE6 | XPGBWT-HE-0000-00KE6 | |
| | | S2 | 148 | 163 | | XPGBWT-HE-0000-00JE6 | |
| | | R5 | 139 | 153 | | | XPGBWT-UE-0000-00HE6 |
| | | R4 | 130 | 143 | | | XPGBWT-UE-0000-00GE6 |
| | | R3 | 122 | 134 | | | XPGBWT-UE-0000-00FE6 |
| F7 | 3250 K | S5 | 172 | 189 | XPGBWT-BE-0000-00MF7 | | |
| | | S4 | 164 | 180 | XPGBWT-BE-0000-00LF7 | | |
| | | S3 | 156 | 171 | XPGBWT-BE-0000-00KF7 | XPGBWT-HE-0000-00KF7 | |
| | | S2 | 148 | 163 | | XPGBWT-HE-0000-00JF7 | |
| | | R5 | 139 | 153 | | XPGBWT-HE-0000-00HF7 | |
| | | R4 | 130 | 143 | | | XPGBWT-UE-0000-00GF7 |
| | | R3 | 122 | 134 | | | XPGBWT-UE-0000-00FF7 |
| E7 | 3000 K | S5 | 172 | 189 | XPGBWT-BE-0000-00ME7 | | |
| | | S4 | 164 | 180 | XPGBWT-BE-0000-00LE7 | | |
| | | S3 | 156 | 171 | XPGBWT-BE-0000-00KE7 | XPGBWT-HE-0000-00KE7 | |
| | | S2 | 148 | 163 | | XPGBWT-HE-0000-00JE7 | |
| | | R5 | 139 | 153 | | XPGBWT-HE-0000-00HE7 | |
| | | R4 | 130 | 143 | | | XPGBWT-UE-0000-00GE7 |
| | | R3 | 122 | 134 | | | XPGBWT-UE-0000-00FE7 |
| R2 | 114 | 125 | | | XPGBWT-UE-0000-00EE7 | | |

Notes

- For additional order codes NOT recommended for new designs please see the Appendix section starting on page 40 .
- Cree LED maintains a tolerance of ±7% on flux and power measurements, ±0.005 on chromaticity (CCx, CCy) measurements and a tolerance of ±2 on CRI measurements. See the Measurements section (page 33).
- XP-G2 LED order codes specify only a minimum flux bin and not a maximum. Cree LED may ship reels in flux bins higher than the minimum specified by the order code without advance notice. Shipments will always adhere to the chromaticity bin restrictions specified by the order code.
- * Flux values @ 25 °C are calculated and for reference only.

ORDER CODES SUGGESTED FOR NEW DESIGNS - HIGH EFFICACY (T_j = 85 °C) - CONTINUED

| Chromaticity | | Minimum Luminous Flux (lm) @ 350 mA | | | Order Codes | | |
|--------------|--------|-------------------------------------|-------------------|--------------------|----------------------|----------------------|----------------------|
| Kit | CCT | Code | Flux (lm) @ 85 °C | Flux (lm) @ 25 °C* | 70 CRI Minimum | 80 CRI Minimum | 90 CRI Minimum |
| F8 | 2850 K | S4 | 164 | 180 | XPGBWT-BE-0000-00LF8 | | |
| | | S3 | 156 | 171 | XPGBWT-BE-0000-00KF8 | | |
| | | S2 | 148 | 163 | | XPGBWT-HE-0000-00JF8 | |
| | | R5 | 139 | 153 | | XPGBWT-HE-0000-00HF8 | |
| | | R4 | 130 | 143 | | | |
| | | R3 | 122 | 134 | | | XPGBWT-UE-0000-00FF8 |
| | | R2 | 114 | 125 | | | XPGBWT-UE-0000-00EF8 |
| E8 | 2700 K | S4 | 164 | 180 | XPGBWT-BE-0000-00LE8 | | |
| | | S3 | 156 | 171 | XPGBWT-BE-0000-00KE8 | | |
| | | S2 | 148 | 163 | | XPGBWT-HE-0000-00JE8 | |
| | | R5 | 139 | 153 | | XPGBWT-HE-0000-00HE8 | |
| | | R4 | 130 | 143 | | | |
| | | R3 | 122 | 134 | | | XPGBWT-UE-0000-00FE8 |
| | | R2 | 114 | 125 | | | XPGBWT-UE-0000-00EE8 |

Notes

- For additional order codes NOT recommended for new designs please see the Appendix section starting on page 40 .
- Cree LED maintains a tolerance of ±7% on flux and power measurements, ±0.005 on chromaticity (CCx, CCy) measurements and a tolerance of ±2 on CRI measurements. See the Measurements section (page 33).
- XP-G2 LED order codes specify only a minimum flux bin and not a maximum. Cree LED may ship reels in flux bins higher than the minimum specified by the order code without advance notice. Shipments will always adhere to the chromaticity bin restrictions specified by the order code.
- * Flux values @ 25 °C are calculated and for reference only.

ORDER CODES SUGGESTED FOR NEW DESIGNS - STANDARD (T_j = 85 °C)

The following table provides order codes for XLamp Standard XP-G2 LEDs. For a complete description of the order code nomenclature, please see the Bin and Order Code Formats section (page 31). For definitions of the chromaticity kits, please see the Standard Chromaticity Kits section (page 30).

| Chromaticity | | Minimum Luminous Flux (lm) @ 350 mA | | | Order Codes |
|--------------|--------|--|----------------------|-----------------------|----------------------|
| Kit | CCT | Code | Flux (lm) @ 85 °C | Flux (lm) @ 25 °C* | 70 CRI Typical |
| 51 | 6200 K | S5 | 172 | 189 | XPGBWT-L1-0000-00M51 |
| | | S4 | 164 | 180 | XPGBWT-L1-0000-00L51 |
| | | S3 | 156 | 171 | XPGBWT-L1-0000-00K51 |
| | | S2 | 148 | 163 | XPGBWT-L1-0000-00J51 |
| 53 | 6000 K | S5 | 172 | 189 | XPGBWT-L1-0000-00M53 |
| | | S4 | 164 | 180 | XPGBWT-L1-0000-00L53 |
| | | S3 | 156 | 171 | XPGBWT-L1-0000-00K53 |
| | | S2 | 148 | 163 | XPGBWT-L1-0000-00J53 |
| 50 | 6200 K | S5 | 172 | 189 | XPGBWT-L1-0000-00M50 |
| | | S4 | 164 | 180 | XPGBWT-L1-0000-00L50 |
| | | S3 | 156 | 171 | XPGBWT-L1-0000-00K50 |
| | | S2 | 148 | 163 | XPGBWT-L1-0000-00J50 |
| E1 | 6500 K | S5 | 172 | 189 | XPGBWT-L1-0000-00ME1 |
| | | S4 | 164 | 180 | XPGBWT-L1-0000-00LE1 |
| | | S3 | 156 | 171 | XPGBWT-L1-0000-00KE1 |
| | | S2 | 148 | 163 | XPGBWT-L1-0000-00JE1 |
| E2 | 5700 K | S5 | 172 | 189 | XPGBWT-L1-0000-00ME2 |
| | | S4 | 164 | 180 | XPGBWT-L1-0000-00LE2 |
| | | S3 | 156 | 171 | XPGBWT-L1-0000-00KE2 |
| | | S2 | 148 | 163 | XPGBWT-L1-0000-00JE2 |

Notes

- For additional order codes NOT recommended for new designs please see the Appendix section starting on page 40 .
- Cree LED maintains a tolerance of ±7% on flux and power measurements, ±0.005 on chromaticity (CCx, CCy) measurements and a tolerance of ±2 on CRI measurements. See the Measurements section (page 33).
- XP-G2 LED order codes specify only a minimum flux bin and not a maximum. Cree LED may ship reels in flux bins higher than the minimum specified by the order code without advance notice. Shipments will always adhere to the chromaticity bin restrictions specified by the order code.
- * Flux values @ 25 °C are calculated and for reference only.

ORDER CODES SUGGESTED FOR NEW DESIGNS - STANDARD (T_j = 85 °C) - CONTINUED

| Chromaticity | | Minimum Luminous Flux (lm) @ 350 mA | | | Order Codes | |
|--------------|--------|--|----------------------|-----------------------|----------------------|----------------------|
| Kit | CCT | Code | Flux (lm) @ 85 °C | Flux (lm) @ 25 °C* | 70 CRI Typical | 80 CRI Minimum |
| E3 | 5000 K | S5 | 172 | 189 | XPGBWT-01-0000-00ME3 | |
| | | S4 | 164 | 180 | XPGBWT-01-0000-00LE3 | |
| | | S3 | 156 | 171 | XPGBWT-01-0000-00KE3 | |
| | | S2 | 148 | 163 | XPGBWT-01-0000-00JE3 | |
| F4 | 4750 K | S5 | 172 | 189 | XPGBWT-01-0000-00MF4 | |
| | | S4 | 164 | 180 | XPGBWT-01-0000-00LF4 | |
| | | S3 | 156 | 171 | XPGBWT-01-0000-00KF4 | |
| | | S2 | 148 | 163 | XPGBWT-01-0000-00JF4 | |
| E4 | 4500 K | S5 | 172 | 189 | XPGBWT-01-0000-00ME4 | |
| | | S4 | 164 | 180 | XPGBWT-01-0000-00LE4 | |
| | | S3 | 156 | 171 | XPGBWT-01-0000-00KE4 | |
| | | S2 | 148 | 163 | XPGBWT-01-0000-00JE4 | |
| F5 | 4250 K | S5 | 172 | 189 | XPGBWT-01-0000-00MF5 | |
| | | S4 | 164 | 180 | XPGBWT-01-0000-00LF5 | |
| | | S3 | 156 | 171 | XPGBWT-01-0000-00KF5 | |
| | | S2 | 148 | 163 | XPGBWT-01-0000-00JF5 | |
| E5 | 4000 K | S5 | 172 | 189 | XPGBWT-01-0000-00ME5 | |
| | | S4 | 164 | 180 | XPGBWT-01-0000-00LE5 | |
| | | S3 | 156 | 171 | XPGBWT-01-0000-00KE5 | XPGBWT-H1-0000-00KE5 |
| | | S2 | 148 | 163 | XPGBWT-01-0000-00JE5 | XPGBWT-H1-0000-00JE5 |
| | | R5 | 139 | 153 | | XPGBWT-H1-0000-00HE5 |
| | | R4 | 130 | 143 | | XPGBWT-H1-0000-00GE5 |
| Z5 | 4000 K | S3 | 156 | 171 | | XPGBWT-H1-0000-00KZ5 |
| | | S2 | 148 | 163 | | XPGBWT-H1-0000-00JZ5 |
| | | R5 | 139 | 153 | | XPGBWT-H1-0000-00HZ5 |
| | | R4 | 130 | 143 | | XPGBWT-H1-0000-00GZ5 |

Notes

- For additional order codes NOT recommended for new designs please see the Appendix section starting on page 40 .
- Cree LED maintains a tolerance of ±7% on flux and power measurements, ±0.005 on chromaticity (CCx, CCy) measurements and a tolerance of ±2 on CRI measurements. See the Measurements section (page 33).
- XP-G2 LED order codes specify only a minimum flux bin and not a maximum. Cree LED may ship reels in flux bins higher than the minimum specified by the order code without advance notice. Shipments will always adhere to the chromaticity bin restrictions specified by the order code.
- * Flux values @ 25 °C are calculated and for reference only.

ORDER CODES SUGGESTED FOR NEW DESIGNS - STANDARD (T_j = 85 °C) - CONTINUED

| Chromaticity | | Minimum Luminous Flux (lm) @ 350 mA | | | Order Codes | | | |
|--------------|--------|-------------------------------------|-------------------|--------------------|----------------------|----------------------|----------------------|----------------------|
| Kit | CCT | Code | Flux (lm) @ 85 °C | Flux (lm) @ 25 °C* | 70 CRI Typical | 80 CRI Typical | 80 CRI Minimum | 90 CRI Minimum |
| F6 | 3750 K | S4 | 164 | 180 | XPGBWT-01-0000-00LF6 | | | |
| | | S3 | 156 | 171 | XPGBWT-01-0000-00KF6 | XPGBWT-L1-0000-00KF6 | XPGBWT-H1-0000-00KF6 | |
| | | S2 | 148 | 163 | XPGBWT-01-0000-00JF6 | XPGBWT-L1-0000-00JF6 | XPGBWT-H1-0000-00JF6 | |
| | | R5 | 139 | 153 | XPGBWT-01-0000-00HF6 | XPGBWT-L1-0000-00HF6 | XPGBWT-H1-0000-00HF6 | |
| | | R4 | 130 | 143 | | XPGBWT-L1-0000-00GF6 | XPGBWT-H1-0000-00GF6 | |
| E6 | 3500 K | S4 | 164 | 180 | XPGBWT-01-0000-00LE6 | | | |
| | | S3 | 156 | 171 | XPGBWT-01-0000-00KE6 | | | |
| | | S2 | 148 | 163 | XPGBWT-01-0000-00JE6 | XPGBWT-L1-0000-00JE6 | XPGBWT-H1-0000-00JE6 | |
| | | R5 | 139 | 153 | XPGBWT-01-0000-00HE6 | XPGBWT-L1-0000-00HE6 | XPGBWT-H1-0000-00HE6 | |
| | | R4 | 130 | 143 | | XPGBWT-L1-0000-00GE6 | XPGBWT-H1-0000-00GE6 | |
| Z6 | 3500 K | S2 | 148 | 163 | | XPGBWT-L1-0000-00JZ6 | XPGBWT-H1-0000-00JZ6 | |
| | | R5 | 139 | 153 | | XPGBWT-L1-0000-00HZ6 | XPGBWT-H1-0000-00HZ6 | |
| | | R4 | 130 | 143 | | XPGBWT-L1-0000-00GZ6 | XPGBWT-H1-0000-00GZ6 | |
| F7 | 3250 K | S4 | 164 | 180 | XPGBWT-01-0000-00LF7 | | | |
| | | S3 | 156 | 171 | XPGBWT-01-0000-00KF7 | | | |
| | | S2 | 148 | 163 | XPGBWT-01-0000-00JF7 | XPGBWT-L1-0000-00JF7 | XPGBWT-H1-0000-00JF7 | |
| | | R5 | 139 | 153 | XPGBWT-01-0000-00HF7 | XPGBWT-L1-0000-00HF7 | XPGBWT-H1-0000-00HF7 | |
| | | R4 | 130 | 143 | | XPGBWT-L1-0000-00GF7 | XPGBWT-H1-0000-00GF7 | |
| E7 | 3000 K | S3 | 156 | 171 | XPGBWT-01-0000-00KE7 | | | |
| | | S2 | 148 | 163 | XPGBWT-01-0000-00JE7 | XPGBWT-L1-0000-00JE7 | XPGBWT-H1-0000-00JE7 | |
| | | R5 | 139 | 153 | XPGBWT-01-0000-00HE7 | XPGBWT-L1-0000-00HE7 | XPGBWT-H1-0000-00HE7 | |
| | | R4 | 130 | 143 | XPGBWT-01-0000-00GE7 | XPGBWT-L1-0000-00GE7 | XPGBWT-H1-0000-00GE7 | XPGBWT-U1-0000-00GE7 |
| | | R3 | 122 | 134 | | XPGBWT-L1-0000-00FE7 | XPGBWT-H1-0000-00FE7 | XPGBWT-U1-0000-00FE7 |
| | | R2 | 114 | 125 | | | | XPGBWT-U1-0000-00EE7 |
| | | Q5 | 107 | 118 | | | | XPGBWT-U1-0000-00DE7 |

Notes

- For additional order codes NOT recommended for new designs please see the Appendix section starting on page 40 .
- Cree LED maintains a tolerance of ±7% on flux and power measurements, ±0.005 on chromaticity (CCx, CCy) measurements and a tolerance of ±2 on CRI measurements. See the Measurements section (page 33).
- XP-G2 LED order codes specify only a minimum flux bin and not a maximum. Cree LED may ship reels in flux bins higher than the minimum specified by the order code without advance notice. Shipments will always adhere to the chromaticity bin restrictions specified by the order code.
- * Flux values @ 25 °C are calculated and for reference only.

ORDER CODES SUGGESTED FOR NEW DESIGNS - STANDARD (T_j = 85 °C) - CONTINUED

| Chromaticity | | Minimum Luminous Flux (lm) @ 350 mA | | | Order Codes | | | |
|--------------|--------|--|----------------------|-----------------------|----------------|----------------------|----------------------|----------------------|
| Kit | CCT | Code | Flux (lm) @ 85 °C | Flux (lm) @ 25 °C* | 70 CRI Typical | 80 CRI Typical | 80 CRI Minimum | 90 CRI Minimum |
| Z7 | 3000 K | R5 | 139 | 153 | | XPGBWT-L1-0000-00HZ7 | XPGBWT-H1-0000-00HZ7 | |
| | | R4 | 130 | 143 | | XPGBWT-L1-0000-00GZ7 | XPGBWT-H1-0000-00GZ7 | |
| | | R3 | 122 | 134 | | XPGBWT-L1-0000-00FZ7 | XPGBWT-H1-0000-00FZ7 | XPGBWT-U1-0000-00FZ7 |
| | | R2 | 114 | 125 | | | | XPGBWT-U1-0000-00EZ7 |
| | | Q5 | 107 | 118 | | | | XPGBWT-U1-0000-00DZ7 |
| F8 | 2850 K | R5 | 139 | 153 | | XPGBWT-L1-0000-00HF8 | XPGBWT-H1-0000-00HF8 | |
| | | R4 | 130 | 143 | | XPGBWT-L1-0000-00GF8 | XPGBWT-H1-0000-00GF8 | |
| | | R3 | 122 | 134 | | XPGBWT-L1-0000-00FF8 | XPGBWT-H1-0000-00FF8 | XPGBWT-U1-0000-00FF8 |
| | | R2 | 114 | 125 | | | | XPGBWT-U1-0000-00EF8 |
| | | Q5 | 107 | 118 | | | | XPGBWT-U1-0000-00DF8 |
| E8 | 2700 K | R5 | 139 | 153 | | XPGBWT-L1-0000-00HE8 | XPGBWT-H1-0000-00HE8 | |
| | | R4 | 130 | 143 | | XPGBWT-L1-0000-00GE8 | XPGBWT-H1-0000-00GE8 | |
| | | R3 | 122 | 134 | | XPGBWT-L1-0000-00FE8 | XPGBWT-H1-0000-00FE8 | |
| | | R2 | 114 | 125 | | | | XPGBWT-U1-0000-00EE8 |
| | | Q5 | 107 | 118 | | | | XPGBWT-U1-0000-00DE8 |
| | | Q4 | 100 | 110 | | | | XPGBWT-U1-0000-00CE8 |
| Z8 | 2700 K | R4 | 130 | 143 | | XPGBWT-L1-0000-00GZ8 | XPGBWT-H1-0000-00GZ8 | |
| | | R3 | 122 | 134 | | XPGBWT-L1-0000-00FZ8 | XPGBWT-H1-0000-00FZ8 | |
| | | R2 | 114 | 125 | | XPGBWT-L1-0000-00EZ8 | XPGBWT-H1-0000-00EZ8 | |
| | | Q5 | 107 | 118 | | | | XPGBWT-U1-0000-00DZ8 |
| | | Q4 | 100 | 110 | | | | XPGBWT-U1-0000-00CZ8 |
| | | Q3 | 93.9 | 103 | | | | XPGBWT-U1-0000-00BZ8 |

Notes

- For additional order codes NOT recommended for new designs please see the Appendix section starting on page 40 .
- Cree LED maintains a tolerance of ±7% on flux and power measurements, ±0.005 on chromaticity (CCx, CCy) measurements and a tolerance of ±2 on CRI measurements. See the Measurements section (page 33).
- XP-G2 LED order codes specify only a minimum flux bin and not a maximum. Cree LED may ship reels in flux bins higher than the minimum specified by the order code without advance notice. Shipments will always adhere to the chromaticity bin restrictions specified by the order code.
- * Flux values @ 25 °C are calculated and for reference only.

FLUX CHARACTERISTICS - BROADCAST ORDER CODES AND BINS ($T_j = 85\text{ }^\circ\text{C}$)

The following table provides order codes for XLamp XP-G2 Broadcast LEDs. For a complete description of the order code nomenclature, please see the Bin and Order Code Formats section (page 31). For definitions of the chromaticity kits, please see the Standard Chromaticity Kits section (page 30).

| Chromaticity | | Minimum Luminous Flux (lm) @ 1050 mA | | | Order Codes | |
|--------------|--------|---|----------------------|-----------------------|-----------------------------------|-----------------------------------|
| Kit | CCT | Flux Bin | Flux (lm) @ 85 °C | Flux (lm) @ 25 °C* | 90 CRI Minimum 90 TLCI Minimum | 95 CRI Minimum 95 TLCI Minimum |
| E2 | 5700 K | R4 | 130 | 143 | XPGBWT-U1-B001-A0GE2 | XPGBWT-Z1-B001-A0FE2 |
| | | R3 | 122 | 134 | | |

Notes

- For additional order codes NOT recommended for new designs please see the Appendix section starting on page 40 .
- Cree LED maintains a tolerance of $\pm 7\%$ on flux and power measurements, ± 0.005 on chromaticity (CCx, CCy) measurements and a tolerance of ± 2 on CRI measurements. See the Measurements section (page 33).
- XP-G2 LED order codes specify only a minimum flux bin and not a maximum. Cree LED may ship reels in flux bins higher than the minimum specified by the order code without advance notice. Shipments will always adhere to the chromaticity bin restrictions specified by the order code.
- * Flux values @ 25 °C are calculated and for reference only.

RELATIVE SPECTRAL POWER DISTRIBUTION

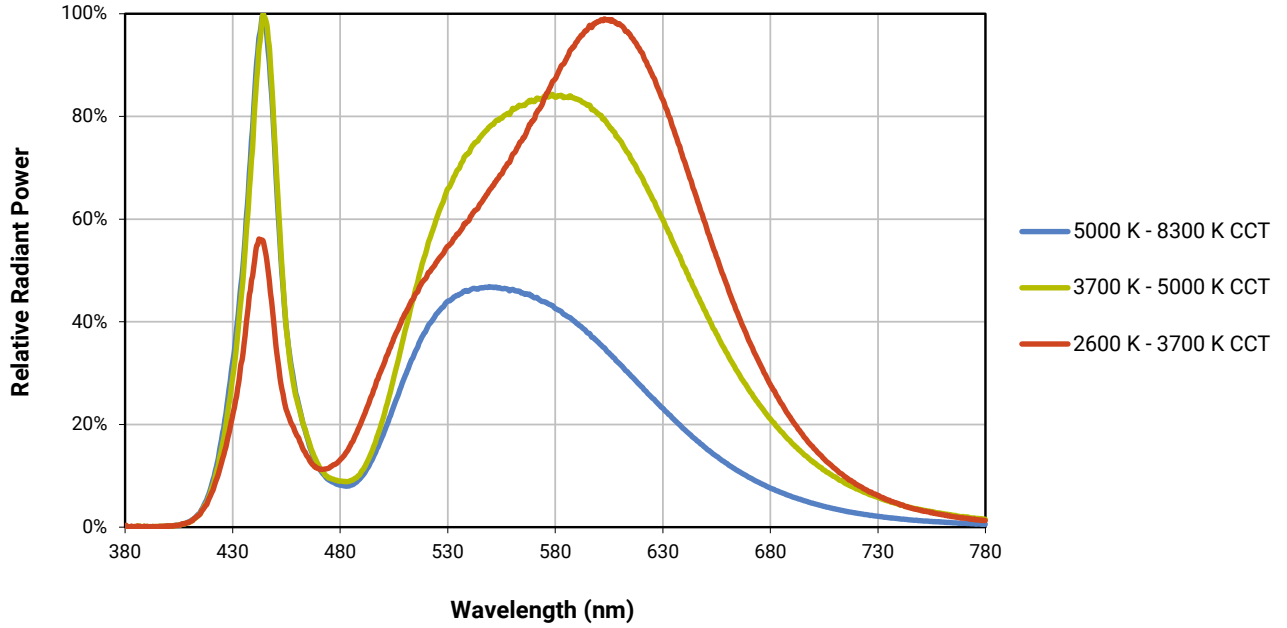

RELATIVE FLUX VS. JUNCTION TEMPERATURE ($I_f = 350$ mA)

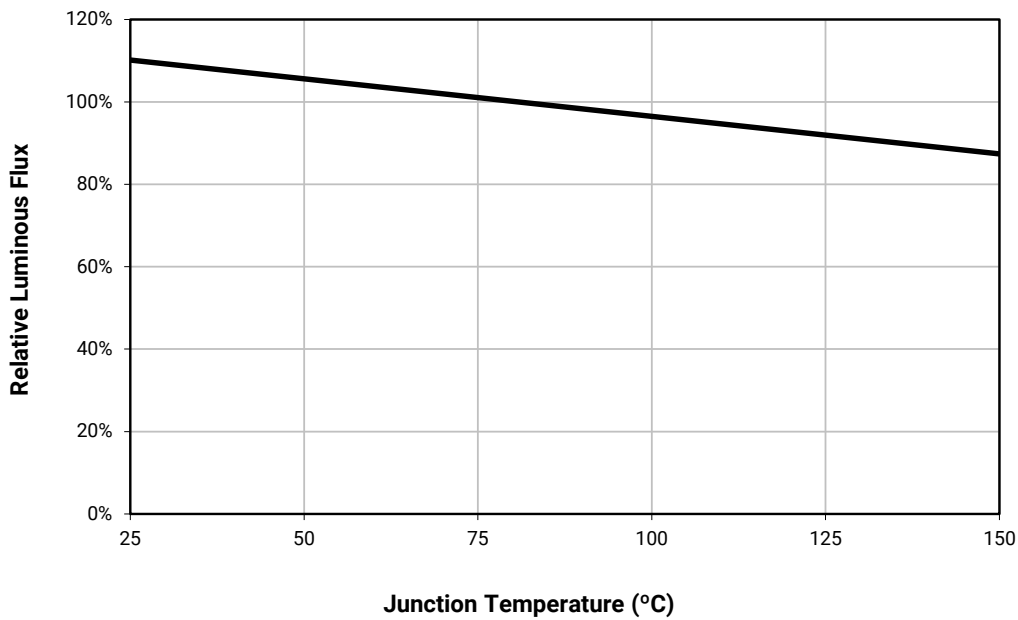

ELECTRICAL CHARACTERISTICS - HIGH EFFICACY ($T_j = 85\text{ }^\circ\text{C}$)

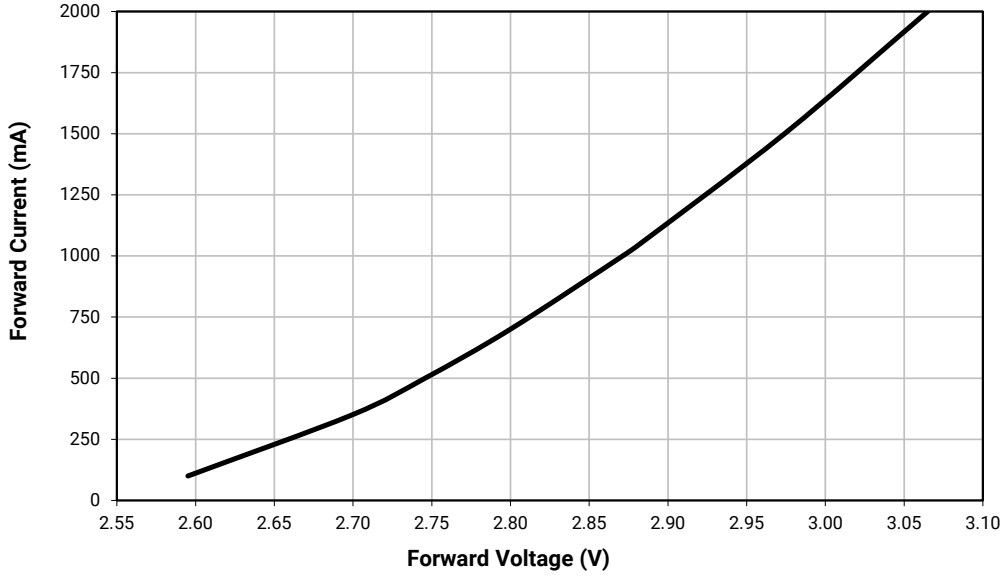

ELECTRICAL CHARACTERISTICS - STANDARD ($T_j = 85\text{ }^\circ\text{C}$)

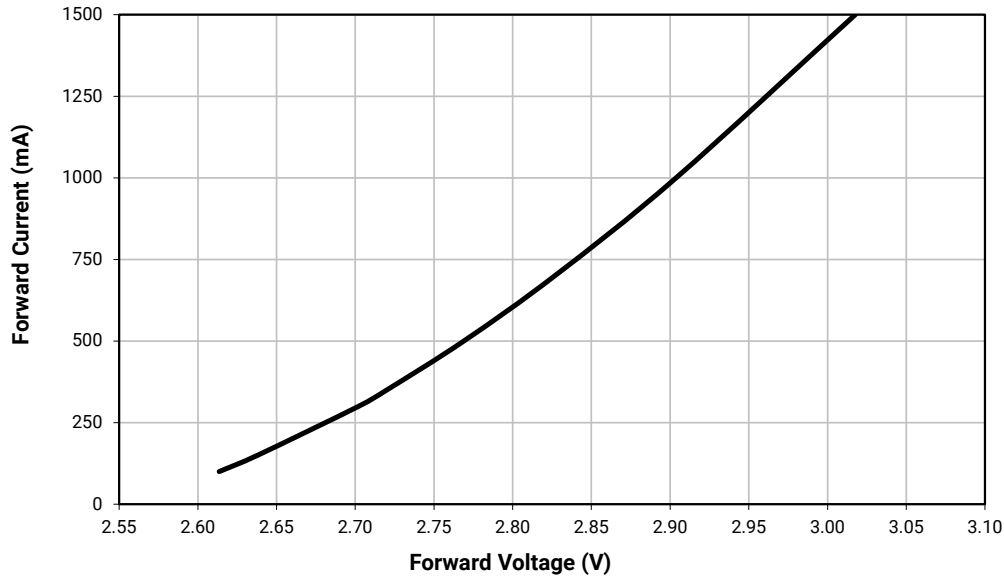

RELATIVE FLUX VS. CURRENT - HIGH EFFICACY ($T_j = 85\text{ }^\circ\text{C}$)

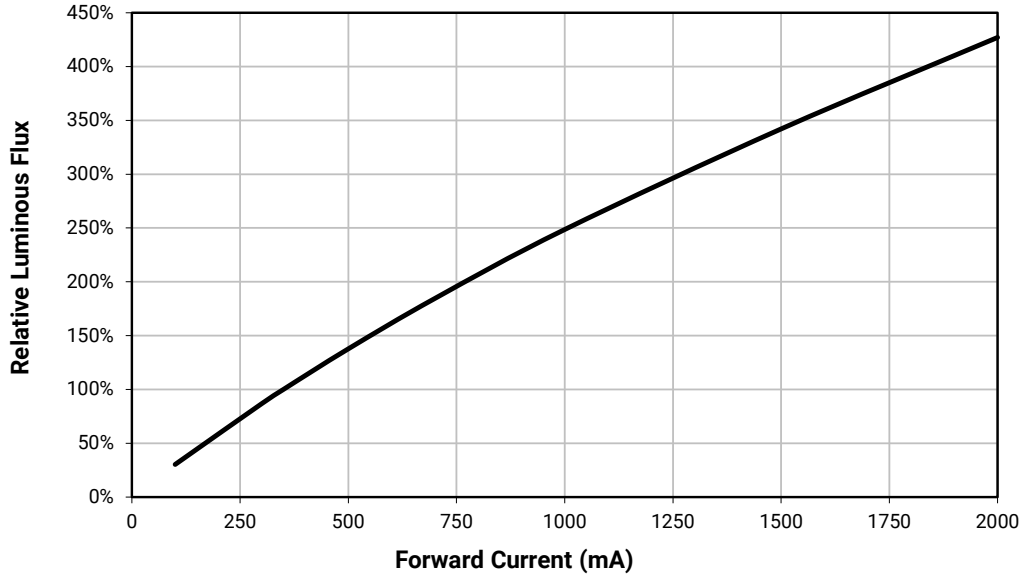

RELATIVE FLUX VS. CURRENT - STANDARD ($T_j = 85\text{ }^\circ\text{C}$)

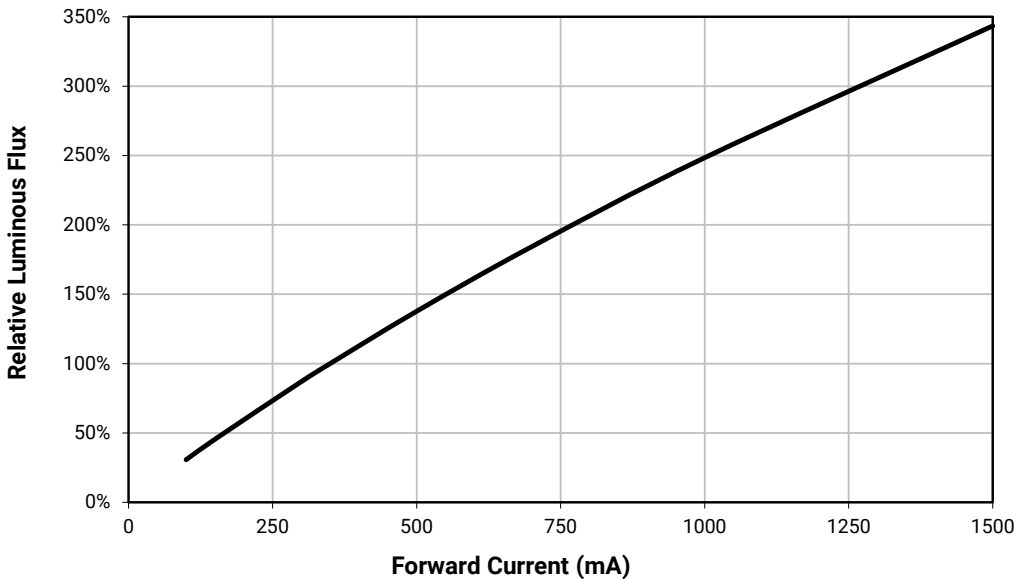

RELATIVE CHROMATICITY VS CURRENT AND TEMPERATURE - HIGH EFFICACY (WARM WHITE)

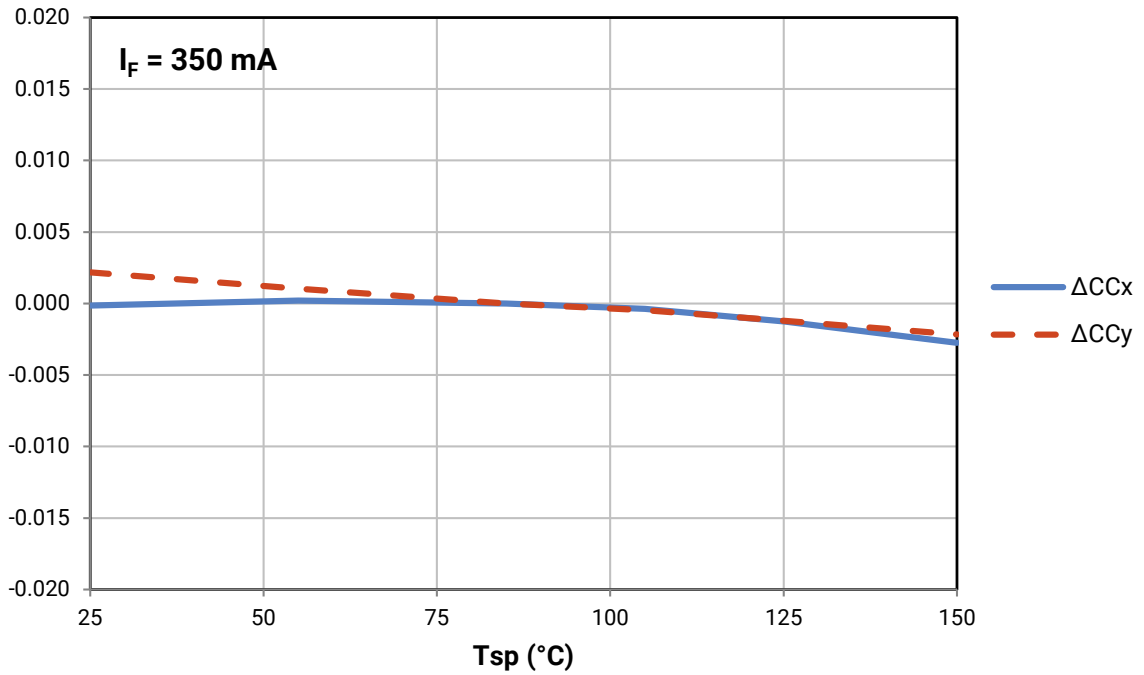
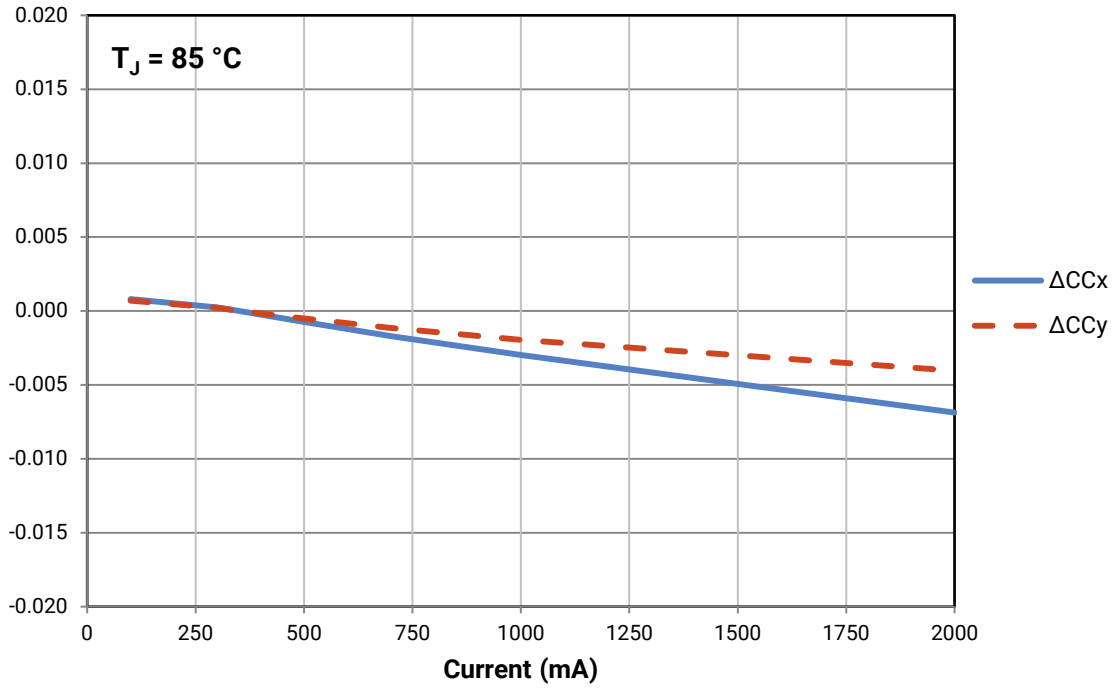

RELATIVE CHROMATICITY VS CURRENT AND TEMPERATURE - STANDARD (WARM WHITE*)

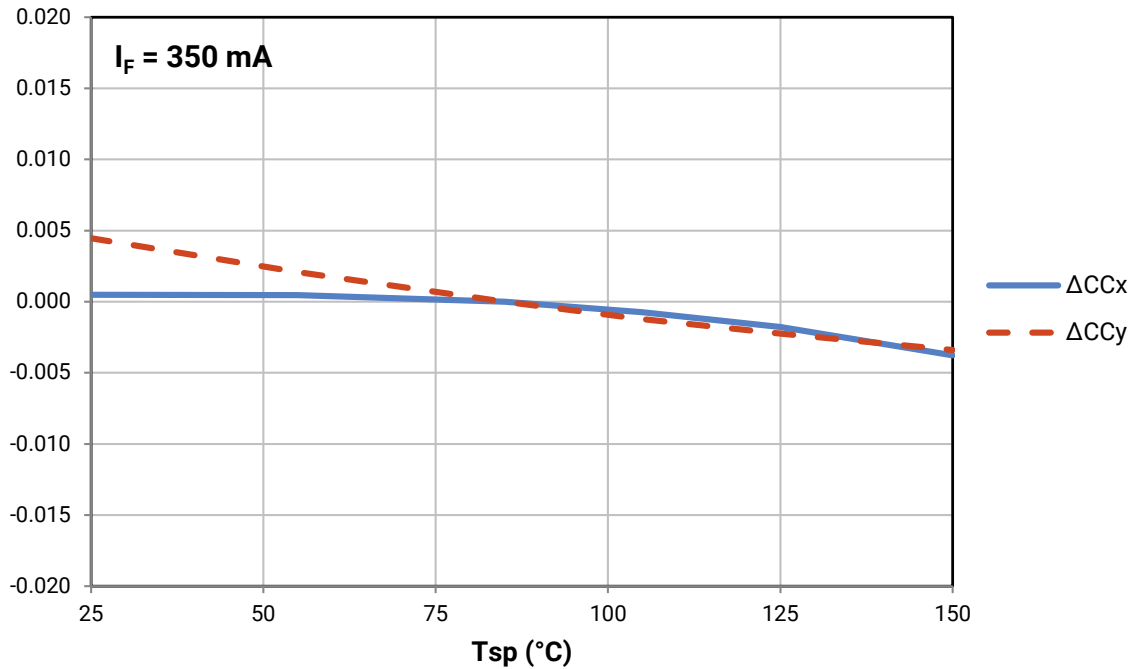
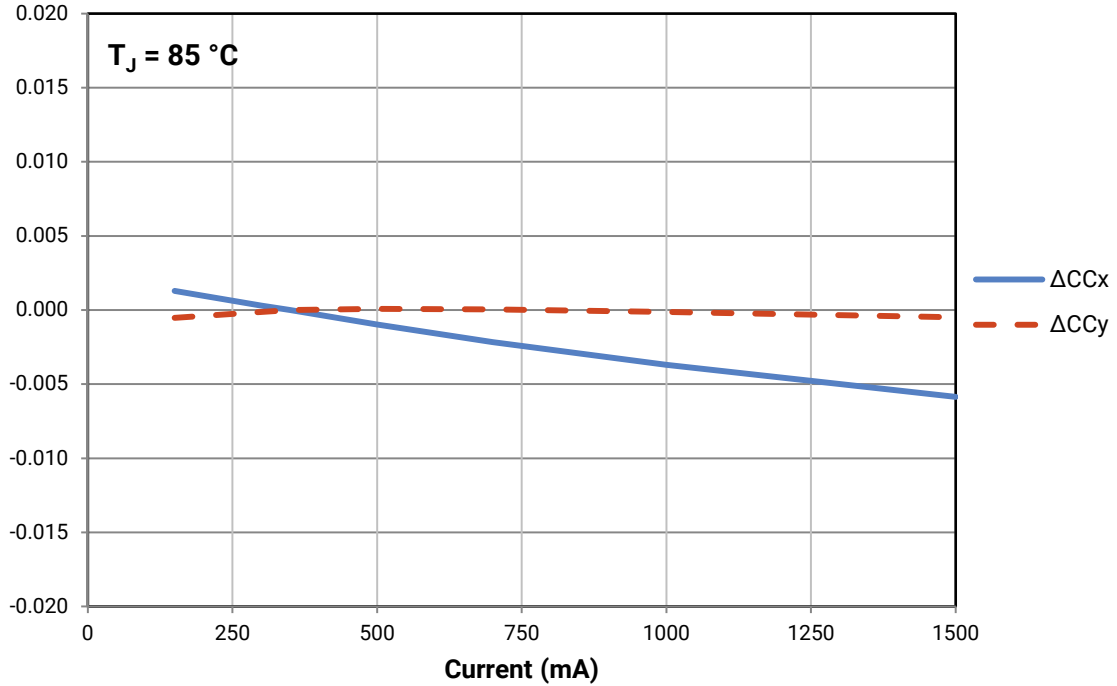

- Warm White XLamp XP-G2 LEDs have a typical CRI of 80.

TYPICAL SPATIAL DISTRIBUTION - HIGH EFFICACY

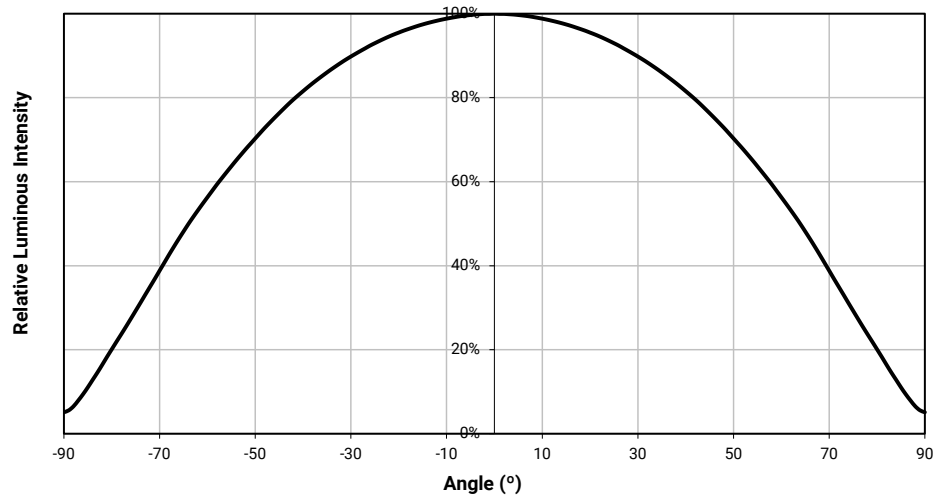

TYPICAL SPATIAL DISTRIBUTION - STANDARD

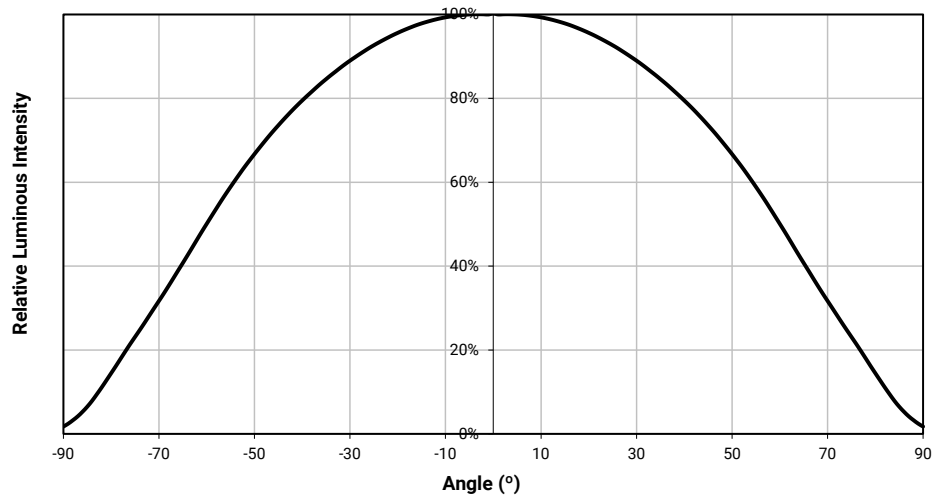

THERMAL DESIGN - HIGH EFFICACY

The maximum forward current is determined by the thermal resistance between the LED junction and ambient. It is crucial for the end product to be designed in a manner that minimizes the thermal resistance from the solder point to ambient in order to optimize lamp life and optical characteristics.

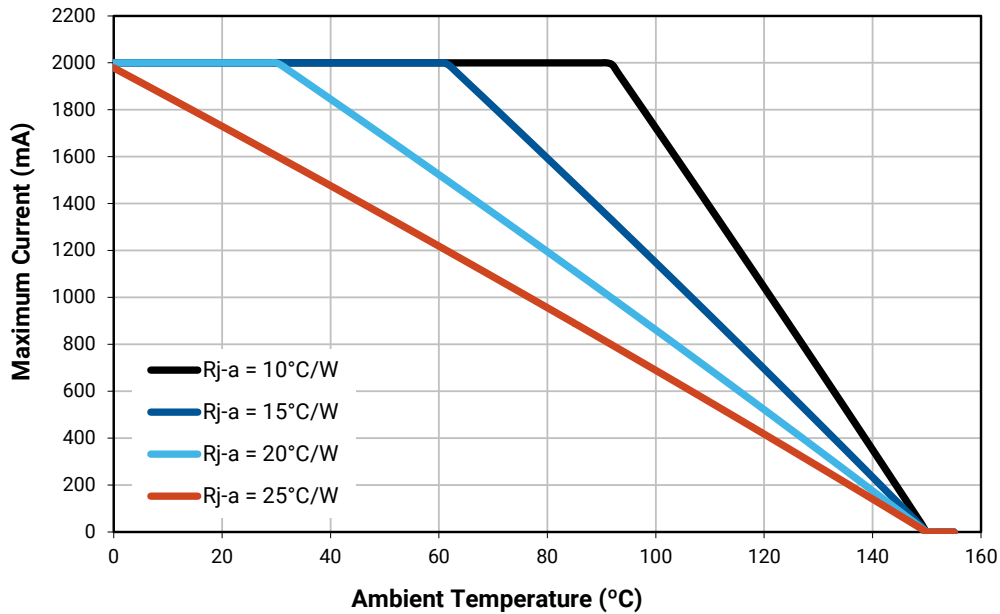

THERMAL DESIGN - STANDARD

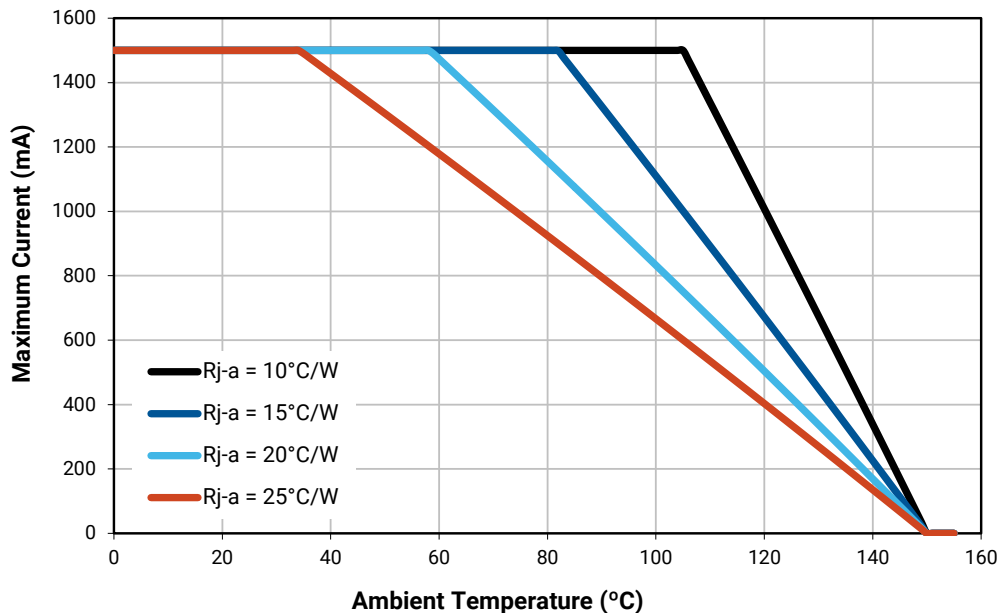

PERFORMANCE GROUPS – LUMINOUS FLUX

XLamp XP-G2 LEDs are tested for luminous flux and placed into one of the following luminous-flux groups:

| Group Code | Minimum Luminous Flux (lm) @ 350 mA | Maximum Luminous Flux (lm) @ 350 mA |
|------------|--|--|
| P2 | 67.2 | 73.9 |
| P3 | 73.9 | 80.6 |
| P4 | 80.6 | 87.4 |
| Q2 | 87.4 | 93.9 |
| Q3 | 93.9 | 100 |
| Q4 | 100 | 107 |
| Q5 | 107 | 114 |
| R2 | 114 | 122 |
| R3 | 122 | 130 |
| R4 | 130 | 139 |
| R5 | 139 | 148 |
| S2 | 148 | 156 |
| S3 | 156 | 164 |
| S4 | 164 | 172 |
| S5 | 172 | 180 |
| S6 | 180 | 188 |
| S7 | 188 | 196 |

PERFORMANCE GROUPS – CHROMATICITY

| Region | x | y | Region | x | y | Region | x | y | Region | x | y |
|--------|--------|--------|--------|--------|--------|--------|--------|--------|--------|--------|--------|
| 0A | 0.2950 | 0.2970 | 0B | 0.2920 | 0.3060 | 0C | 0.2984 | 0.3133 | 0D | 0.2984 | 0.3133 |
| | 0.2920 | 0.3060 | | 0.2895 | 0.3135 | | 0.2962 | 0.3220 | | 0.3048 | 0.3207 |
| | 0.2984 | 0.3133 | | 0.2962 | 0.3220 | | 0.3028 | 0.3304 | | 0.3068 | 0.3113 |
| | 0.3009 | 0.3042 | | 0.2984 | 0.3133 | | 0.3048 | 0.3207 | | 0.3009 | 0.3042 |
| 0R | 0.2980 | 0.2880 | 0S | 0.2895 | 0.3135 | 0T | 0.2962 | 0.3220 | 0U | 0.3037 | 0.2937 |
| | 0.2950 | 0.2970 | | 0.2870 | 0.3210 | | 0.2937 | 0.3312 | | 0.3009 | 0.3042 |
| | 0.3009 | 0.3042 | | 0.2937 | 0.3312 | | 0.3005 | 0.3415 | | 0.3068 | 0.3113 |
| | 0.3037 | 0.2937 | | 0.2962 | 0.3220 | | 0.3028 | 0.3304 | | 0.3093 | 0.2993 |
| 1A | 0.3048 | 0.3207 | 1B | 0.3028 | 0.3304 | 1C | 0.3115 | 0.3391 | 1D | 0.3130 | 0.3290 |
| | 0.3130 | 0.3290 | | 0.3115 | 0.3391 | | 0.3205 | 0.3481 | | 0.3213 | 0.3373 |
| | 0.3144 | 0.3186 | | 0.3130 | 0.3290 | | 0.3213 | 0.3373 | | 0.3221 | 0.3261 |
| | 0.3068 | 0.3113 | | 0.3048 | 0.3207 | | 0.3130 | 0.3290 | | 0.3144 | 0.3186 |
| 1R | 0.3068 | 0.3113 | 1S | 0.3005 | 0.3415 | 1T | 0.3099 | 0.3509 | 1U | 0.3144 | 0.3186 |
| | 0.3144 | 0.3186 | | 0.3099 | 0.3509 | | 0.3196 | 0.3602 | | 0.3221 | 0.3261 |
| | 0.3161 | 0.3059 | | 0.3115 | 0.3391 | | 0.3205 | 0.3481 | | 0.3231 | 0.3120 |
| | 0.3093 | 0.2993 | | 0.3028 | 0.3304 | | 0.3115 | 0.3391 | | 0.3161 | 0.3059 |
| 2A | 0.3215 | 0.3350 | 2B | 0.3207 | 0.3462 | 2C | 0.3290 | 0.3538 | 2D | 0.3290 | 0.3417 |
| | 0.3290 | 0.3417 | | 0.3290 | 0.3538 | | 0.3376 | 0.3616 | | 0.3371 | 0.3490 |
| | 0.3290 | 0.3300 | | 0.3290 | 0.3417 | | 0.3371 | 0.3490 | | 0.3366 | 0.3369 |
| | 0.3222 | 0.3243 | | 0.3215 | 0.3350 | | 0.3290 | 0.3417 | | 0.3290 | 0.3300 |
| 2R | 0.3222 | 0.3243 | 2S | 0.3196 | 0.3602 | 2T | 0.3290 | 0.3690 | 2U | 0.3290 | 0.3300 |
| | 0.3290 | 0.3300 | | 0.3290 | 0.3690 | | 0.3381 | 0.3762 | | 0.3366 | 0.3369 |
| | 0.3290 | 0.3180 | | 0.3290 | 0.3538 | | 0.3376 | 0.3616 | | 0.3361 | 0.3245 |
| | 0.3231 | 0.3120 | | 0.3207 | 0.3462 | | 0.3290 | 0.3538 | | 0.3290 | 0.3180 |
| 3A | 0.3371 | 0.3490 | 3B | 0.3376 | 0.3616 | 3C | 0.3463 | 0.3687 | 3D | 0.3451 | 0.3554 |
| | 0.3451 | 0.3554 | | 0.3463 | 0.3687 | | 0.3551 | 0.3760 | | 0.3533 | 0.3620 |
| | 0.3440 | 0.3427 | | 0.3451 | 0.3554 | | 0.3533 | 0.3620 | | 0.3515 | 0.3487 |
| | 0.3366 | 0.3369 | | 0.3371 | 0.3490 | | 0.3451 | 0.3554 | | 0.3440 | 0.3427 |
| 3R | 0.3366 | 0.3369 | 3S | 0.3381 | 0.3762 | | | | | | |
| | 0.3440 | 0.3428 | | 0.3480 | 0.3840 | | | | | | |
| | 0.3429 | 0.3307 | | 0.3463 | 0.3687 | | | | | | |
| | 0.3361 | 0.3245 | | 0.3376 | 0.3616 | | | | | | |
| 4A | 0.3530 | 0.3597 | 4B | 0.3548 | 0.3736 | 4C | 0.3641 | 0.3804 | 4D | 0.3615 | 0.3659 |
| | 0.3615 | 0.3659 | | 0.3641 | 0.3804 | | 0.3736 | 0.3874 | | 0.3702 | 0.3722 |
| | 0.3590 | 0.3521 | | 0.3615 | 0.3659 | | 0.3702 | 0.3722 | | 0.3670 | 0.3578 |
| | 0.3512 | 0.3465 | | 0.3530 | 0.3597 | | 0.3615 | 0.3659 | | 0.3590 | 0.3521 |

PERFORMANCE GROUPS – CHROMATICITY (CONTINUED)

| Region | x | y | Region | x | y | Region | x | y | Region | x | y |
|--------|--------|--------|--------|--------|--------|--------|--------|--------|--------|--------|--------|
| 5A1 | 0.3670 | 0.3578 | 5A2 | 0.3686 | 0.3649 | 5A3 | 0.3744 | 0.3685 | 5A4 | 0.3726 | 0.3612 |
| | 0.3686 | 0.3649 | | 0.3702 | 0.3722 | | 0.3763 | 0.3760 | | 0.3744 | 0.3685 |
| | 0.3744 | 0.3685 | | 0.3763 | 0.3760 | | 0.3825 | 0.3798 | | 0.3804 | 0.3721 |
| | 0.3726 | 0.3612 | | 0.3744 | 0.3685 | | 0.3804 | 0.3721 | | 0.3783 | 0.3646 |
| 5B1 | 0.3702 | 0.3722 | 5B2 | 0.3719 | 0.3797 | 5B3 | 0.3782 | 0.3837 | 5B4 | 0.3763 | 0.3760 |
| | 0.3719 | 0.3797 | | 0.3736 | 0.3874 | | 0.3802 | 0.3916 | | 0.3782 | 0.3837 |
| | 0.3782 | 0.3837 | | 0.3802 | 0.3916 | | 0.3869 | 0.3958 | | 0.3847 | 0.3877 |
| | 0.3763 | 0.3760 | | 0.3782 | 0.3837 | | 0.3847 | 0.3877 | | 0.3825 | 0.3798 |
| 5C1 | 0.3825 | 0.3798 | 5C2 | 0.3847 | 0.3877 | 5C3 | 0.3912 | 0.3917 | 5C4 | 0.3887 | 0.3836 |
| | 0.3847 | 0.3877 | | 0.3869 | 0.3958 | | 0.3937 | 0.4001 | | 0.3912 | 0.3917 |
| | 0.3912 | 0.3917 | | 0.3937 | 0.4001 | | 0.4006 | 0.4044 | | 0.3978 | 0.3958 |
| | 0.3887 | 0.3836 | | 0.3912 | 0.3917 | | 0.3978 | 0.3958 | | 0.3950 | 0.3875 |
| 5D1 | 0.3783 | 0.3646 | 5D2 | 0.3804 | 0.3721 | 5D3 | 0.3863 | 0.3758 | 5D4 | 0.3840 | 0.3681 |
| | 0.3804 | 0.3721 | | 0.3825 | 0.3798 | | 0.3887 | 0.3836 | | 0.3863 | 0.3758 |
| | 0.3863 | 0.3758 | | 0.3887 | 0.3836 | | 0.3950 | 0.3875 | | 0.3924 | 0.3794 |
| | 0.3840 | 0.3681 | | 0.3863 | 0.3758 | | 0.3924 | 0.3794 | | 0.3898 | 0.3716 |
| 6A1 | 0.3889 | 0.3690 | 6A2 | 0.3915 | 0.3768 | 6A3 | 0.3981 | 0.3800 | 6A4 | 0.3953 | 0.3720 |
| | 0.3915 | 0.3768 | | 0.3941 | 0.3848 | | 0.4010 | 0.3882 | | 0.3981 | 0.3800 |
| | 0.3981 | 0.3800 | | 0.4010 | 0.3882 | | 0.4080 | 0.3916 | | 0.4048 | 0.3832 |
| | 0.3953 | 0.3720 | | 0.3981 | 0.3800 | | 0.4048 | 0.3832 | | 0.4017 | 0.3751 |
| 6B1 | 0.3941 | 0.3848 | 6B2 | 0.3968 | 0.3930 | 6B3 | 0.4040 | 0.3966 | 6B4 | 0.4010 | 0.3882 |
| | 0.3968 | 0.3930 | | 0.3996 | 0.4015 | | 0.4071 | 0.4052 | | 0.4040 | 0.3966 |
| | 0.4040 | 0.3966 | | 0.4071 | 0.4052 | | 0.4146 | 0.4089 | | 0.4113 | 0.4001 |
| | 0.4010 | 0.3882 | | 0.4040 | 0.3966 | | 0.4113 | 0.4001 | | 0.4080 | 0.3916 |
| 6C1 | 0.4080 | 0.3916 | 6C2 | 0.4113 | 0.4001 | 6C3 | 0.4186 | 0.4037 | 6C4 | 0.4150 | 0.3950 |
| | 0.4113 | 0.4001 | | 0.4146 | 0.4089 | | 0.4222 | 0.4127 | | 0.4186 | 0.4037 |
| | 0.4186 | 0.4037 | | 0.4222 | 0.4127 | | 0.4299 | 0.4165 | | 0.4259 | 0.4073 |
| | 0.4150 | 0.3950 | | 0.4186 | 0.4037 | | 0.4259 | 0.4073 | | 0.4221 | 0.3984 |
| 6D1 | 0.4017 | 0.3751 | 6D2 | 0.4048 | 0.3832 | 6D3 | 0.4116 | 0.3865 | 6D4 | 0.4082 | 0.3782 |
| | 0.4048 | 0.3832 | | 0.4080 | 0.3916 | | 0.4150 | 0.3950 | | 0.4116 | 0.3865 |
| | 0.4116 | 0.3865 | | 0.4150 | 0.3950 | | 0.4221 | 0.3984 | | 0.4183 | 0.3898 |
| | 0.4082 | 0.3782 | | 0.4116 | 0.3865 | | 0.4183 | 0.3898 | | 0.4147 | 0.3814 |
| 7A1 | 0.4147 | 0.3814 | 7A2 | 0.4183 | 0.3898 | 7A3 | 0.4242 | 0.3919 | 7A4 | 0.4203 | 0.3833 |
| | 0.4183 | 0.3898 | | 0.4221 | 0.3984 | | 0.4281 | 0.4006 | | 0.4242 | 0.3919 |
| | 0.4242 | 0.3919 | | 0.4281 | 0.4006 | | 0.4342 | 0.4028 | | 0.4300 | 0.3939 |
| | 0.4203 | 0.3833 | | 0.4242 | 0.3919 | | 0.4300 | 0.3939 | | 0.4259 | 0.3853 |

PERFORMANCE GROUPS – CHROMATICITY (CONTINUED)

| Region | x | y | Region | x | y | Region | x | y | Region | x | y |
|--------|--------|--------|--------|--------|--------|--------|--------|--------|--------|--------|--------|
| 7B1 | 0.4221 | 0.3984 | 7B2 | 0.4259 | 0.4073 | 7B3 | 0.4322 | 0.4096 | 7B4 | 0.4281 | 0.4006 |
| | 0.4259 | 0.4073 | | 0.4299 | 0.4165 | | 0.4364 | 0.4188 | | 0.4322 | 0.4096 |
| | 0.4322 | 0.4096 | | 0.4364 | 0.4188 | | 0.4430 | 0.4212 | | 0.4385 | 0.4119 |
| | 0.4281 | 0.4006 | | 0.4322 | 0.4096 | | 0.4385 | 0.4119 | | 0.4342 | 0.4028 |
| 7C1 | 0.4342 | 0.4028 | 7C2 | 0.4385 | 0.4119 | 7C3 | 0.4449 | 0.4141 | 7C4 | 0.4403 | 0.4049 |
| | 0.4385 | 0.4119 | | 0.4430 | 0.4212 | | 0.4496 | 0.4236 | | 0.4449 | 0.4141 |
| | 0.4449 | 0.4141 | | 0.4496 | 0.4236 | | 0.4562 | 0.4260 | | 0.4513 | 0.4164 |
| | 0.4403 | 0.4049 | | 0.4449 | 0.4141 | | 0.4513 | 0.4164 | | 0.4465 | 0.4071 |
| 7D1 | 0.4259 | 0.3853 | 7D2 | 0.4300 | 0.3939 | 7D3 | 0.4359 | 0.3960 | 7D4 | 0.4316 | 0.3873 |
| | 0.4300 | 0.3939 | | 0.4342 | 0.4028 | | 0.4403 | 0.4049 | | 0.4359 | 0.3960 |
| | 0.4359 | 0.3960 | | 0.4403 | 0.4049 | | 0.4465 | 0.4071 | | 0.4418 | 0.3981 |
| | 0.4316 | 0.3873 | | 0.4359 | 0.3960 | | 0.4418 | 0.3981 | | 0.4373 | 0.3893 |
| 8A1 | 0.4373 | 0.3893 | 8A2 | 0.4418 | 0.3981 | 8A3 | 0.4475 | 0.3994 | 8A4 | 0.4428 | 0.3906 |
| | 0.4418 | 0.3981 | | 0.4465 | 0.4071 | | 0.4523 | 0.4085 | | 0.4475 | 0.3994 |
| | 0.4475 | 0.3994 | | 0.4523 | 0.4085 | | 0.4582 | 0.4099 | | 0.4532 | 0.4008 |
| | 0.4428 | 0.3906 | | 0.4475 | 0.3994 | | 0.4532 | 0.4008 | | 0.4483 | 0.3919 |
| 8B1 | 0.4465 | 0.4071 | 8B2 | 0.4513 | 0.4164 | 8B3 | 0.4573 | 0.4178 | 8B4 | 0.4523 | 0.4085 |
| | 0.4513 | 0.4164 | | 0.4562 | 0.4260 | | 0.4624 | 0.4274 | | 0.4573 | 0.4178 |
| | 0.4573 | 0.4178 | | 0.4624 | 0.4274 | | 0.4687 | 0.4289 | | 0.4634 | 0.4193 |
| | 0.4523 | 0.4085 | | 0.4573 | 0.4178 | | 0.4634 | 0.4193 | | 0.4582 | 0.4099 |
| 8C1 | 0.4582 | 0.4099 | 8C2 | 0.4634 | 0.4193 | 8C3 | 0.4695 | 0.4207 | 8C4 | 0.4641 | 0.4112 |
| | 0.4634 | 0.4193 | | 0.4687 | 0.4289 | | 0.4750 | 0.4304 | | 0.4695 | 0.4207 |
| | 0.4695 | 0.4207 | | 0.4750 | 0.4304 | | 0.4813 | 0.4319 | | 0.4756 | 0.4221 |
| | 0.4641 | 0.4112 | | 0.4695 | 0.4207 | | 0.4756 | 0.4221 | | 0.4700 | 0.4126 |
| 8D1 | 0.4483 | 0.3919 | 8D2 | 0.4532 | 0.4008 | 8D3 | 0.4589 | 0.4021 | 8D4 | 0.4538 | 0.3931 |
| | 0.4532 | 0.4008 | | 0.4582 | 0.4099 | | 0.4641 | 0.4112 | | 0.4589 | 0.4021 |
| | 0.4589 | 0.4021 | | 0.4641 | 0.4112 | | 0.4700 | 0.4126 | | 0.4646 | 0.4034 |
| | 0.4538 | 0.3931 | | 0.4589 | 0.4021 | | 0.4646 | 0.4034 | | 0.4593 | 0.3944 |

STANDARD COOL WHITE KITS PLOTTED ON ANSI STANDARD CHROMATICITY REGIONS

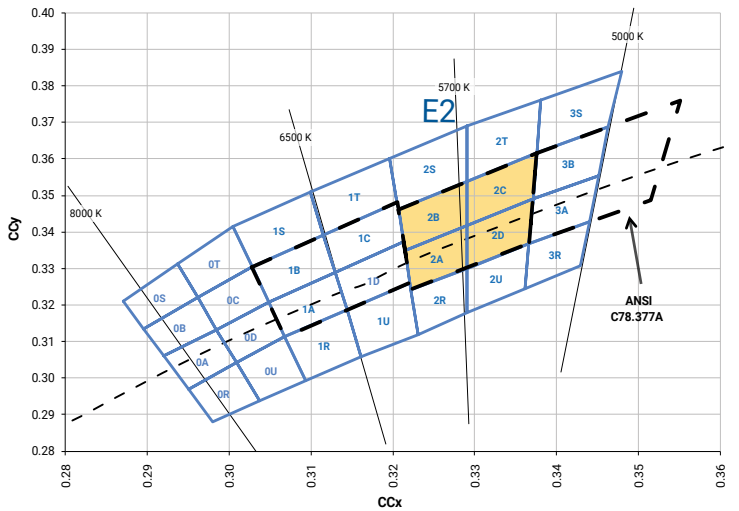
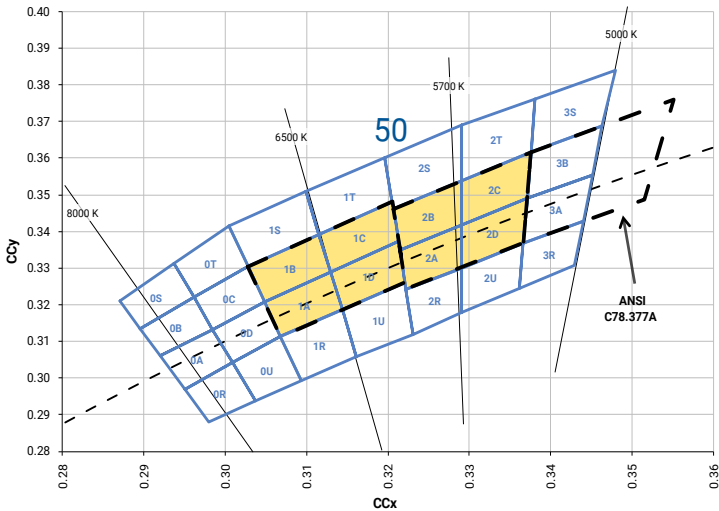
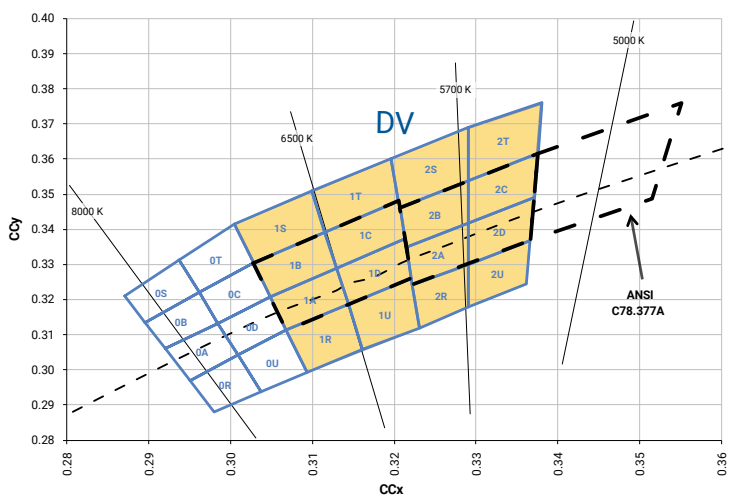
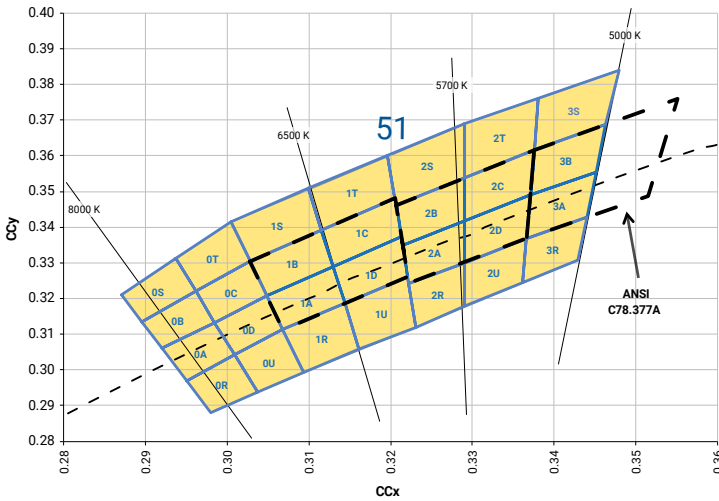
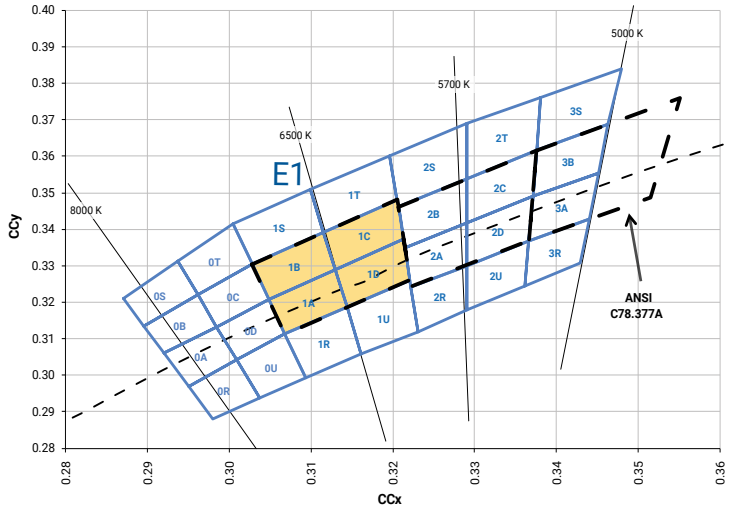
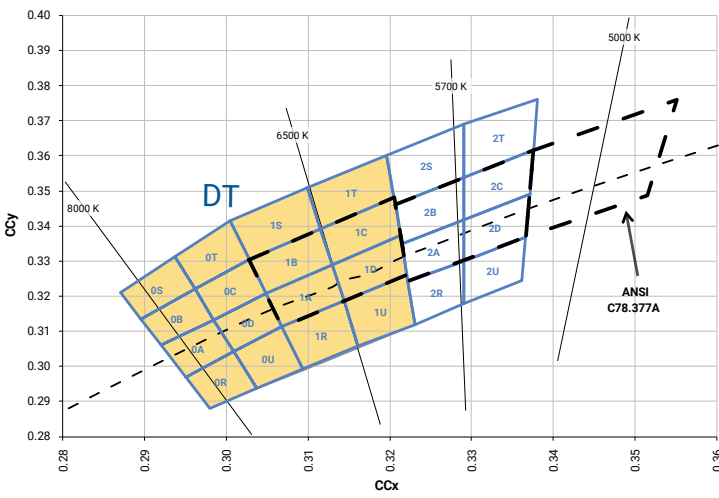

STANDARD COOL WHITE KITS PLOTTED ON ANSI STANDARD CHROMATICITY REGIONS - CONTINUED

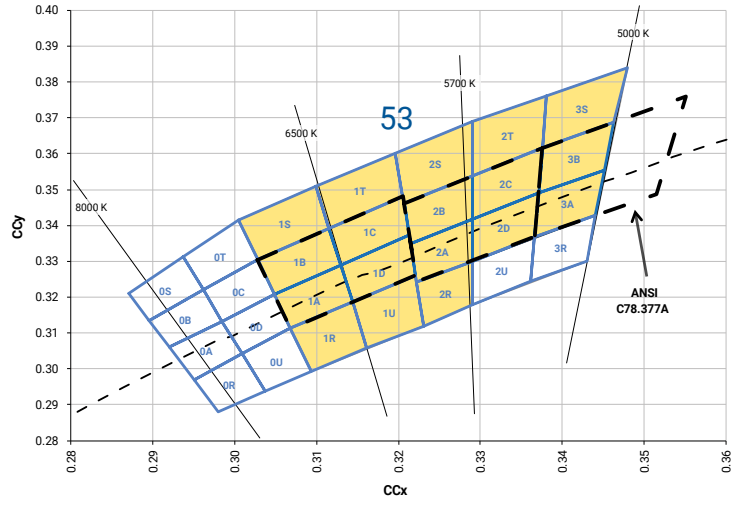

STANDARD WARM AND NEUTRAL WHITE KITS PLOTTED ON ANSI STANDARD CHROMATICITY REGIONS

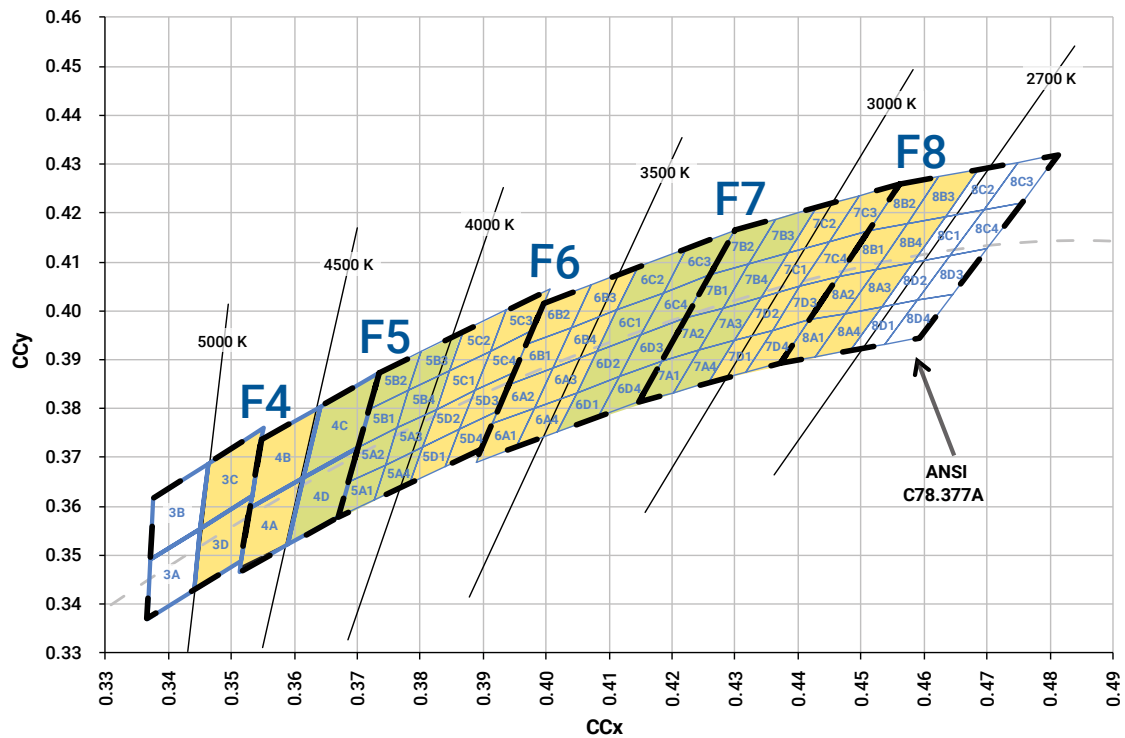
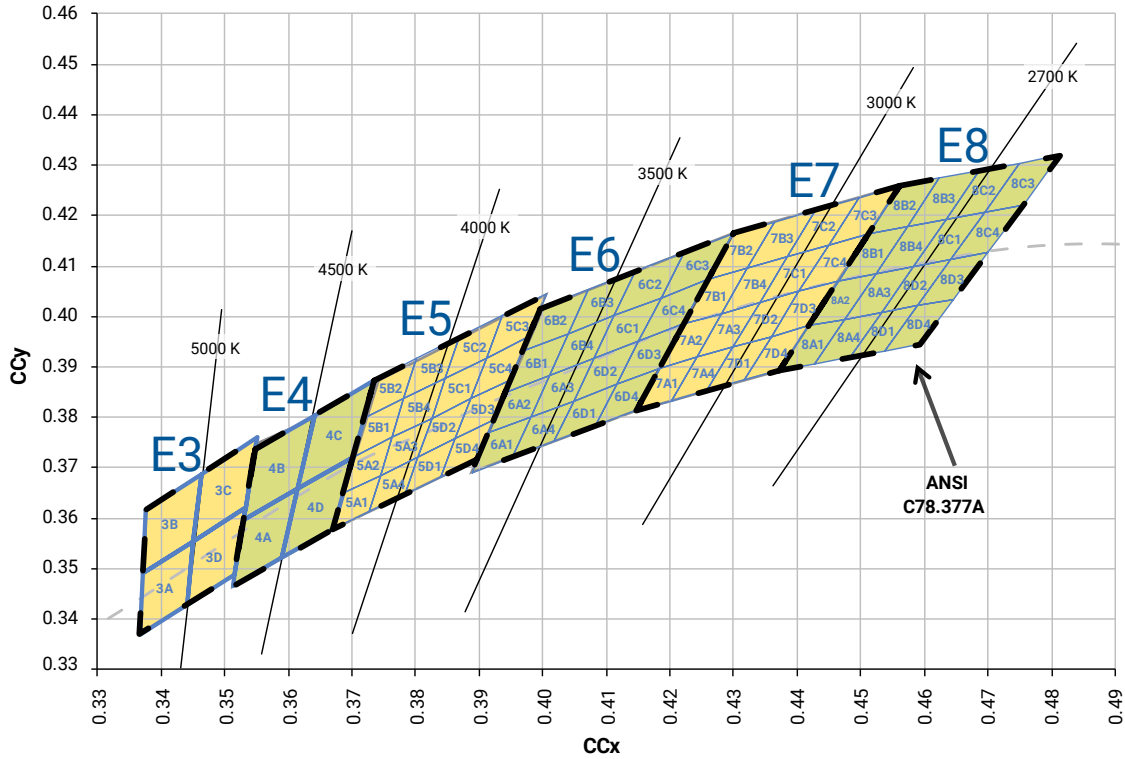

STANDARD WARM AND NEUTRAL WHITE KITS PLOTTED ON ANSI STANDARD CHROMATICITY REGIONS - CONTINUED

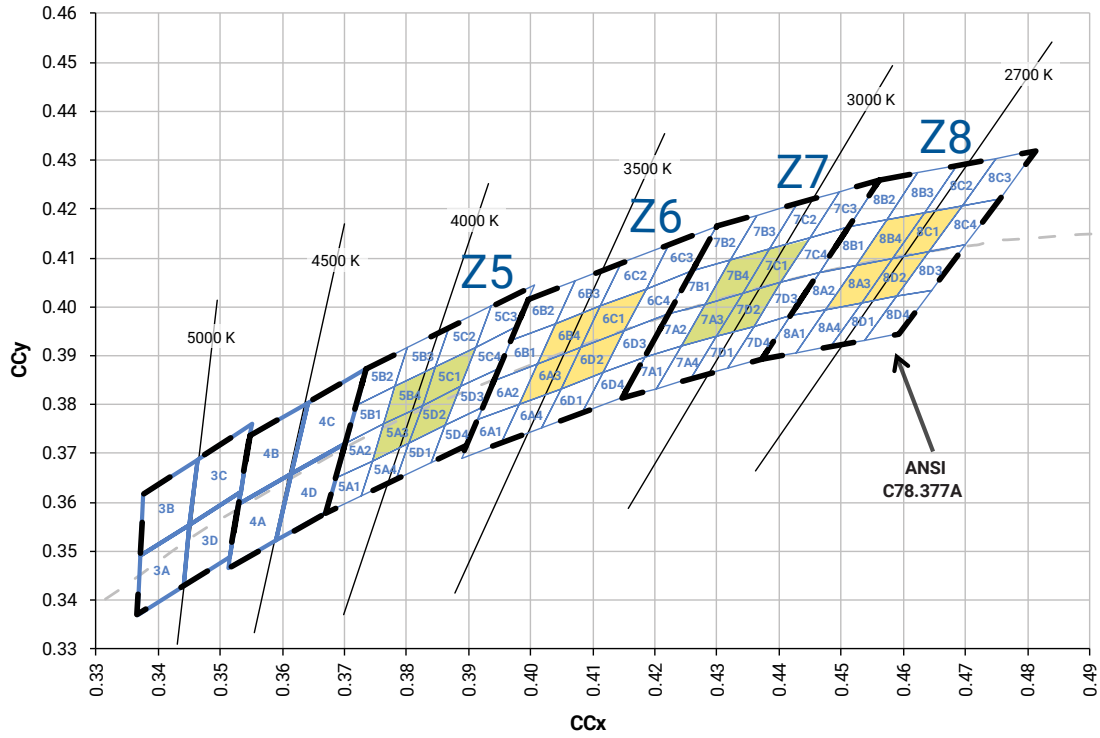

STANDARD CHROMATICITY KITS

The following table provides the chromaticity bins associated with chromaticity kits.

| Color | CCT | Kit | Chromaticity Bins |
|---------------|--------|-----|--|
| Cool White | 7000 K | DT | 0A, 0B, 0C, 0D, 0R, 0S, 0T, 0U, 1A, 1B, 1C, 1D, 1R, 1S, 1T, 1U |
| | 6200 K | 51 | 0A, 0B, 0C, 0D, 0R, 0S, 0T, 0U, 1A, 1B, 1C, 1D, 1R, 1S, 1T, 1U, 2A, 2B, 2C, 2D, 2R, 2S, 2T, 2U, 3A, 3B, 3R, 3S |
| | 6000 K | 53 | 1A, 1B, 1C, 1D, 1R, 1S, 1T, 1U, 2A, 2B, 2C, 2D, 2R, 2S, 2T, 3A, 3B, 3S |
| | 6000 K | 50 | 1A, 1B, 1C, 1D, 2A, 2B, 2C, 2D |
| | 6500 K | E1 | 1A, 1B, 1C, 1D |
| | 6000 K | DV | 1A, 1B, 1C, 1D, 1R, 1S, 1T, 1U, 2A, 2B, 2C, 2D, 2R, 2S, 2T, 2U |
| | 5700 K | E2 | 2A, 2B, 2C, 2D |
| Neutral White | 5000 K | E3 | 3A, 3B, 3C, 3D |
| | 4750 K | F4 | 3C, 3D, 4A, 4B |
| | 4500 K | E4 | 4A, 4B, 4C, 4D |
| | 4250 K | F5 | 4C, 4D, 5A1, 5A2, 5A3, 5A4, 5B1, 5B2, 5B3, 5B4 |
| | 4000 K | E5 | 5A1, 5A2, 5A3, 5A4, 5B1, 5B2, 5B3, 5B4, 5C1, 5C2, 5C3, 5C4, 5D1, 5D2, 5D3, 5D4 |
| | 4000 K | Z5 | 5A3, 5B4, 5C1, 5D2 |
| Warm White | 3750 K | F6 | 5C1, 5C2, 5C3, 5C4, 5D1, 5D2, 5D3, 5D4, 6A1, 6A2, 6A3, 6A4, 6B1, 6B2, 6B3, 6B4 |
| | 3500 K | E6 | 6A1, 6A2, 6A3, 6A4, 6B1, 6B2, 6B3, 6B4, 6C1, 6C2, 6C3, 6C4, 6D1, 6D2, 6D3, 6D4 |
| | 3500 K | Z6 | 6A3, 6B4, 6C1, 6D2 |
| | 3250 K | F7 | 6C1, 6C2, 6C3, 6C4, 6D1, 6D2, 6D3, 6D4, 7A1, 7A2, 7A3, 7A4, 7B1, 7B2, 7B3, 7B4 |
| | 3000 K | E7 | 7A1, 7A2, 7A3, 7A4, 7B1, 7B2, 7B3, 7B4, 7C1, 7C2, 7C3, 7C4, 7D1, 7D2, 7D3, 7D4 |
| | 3000 K | Z7 | 7A3, 7B4, 7C1, 7D2 |
| | 2850 K | F8 | 7C1, 7C2, 7C3, 7C4, 7D1, 7D2, 7D3, 7D4, 8A1, 8A2, 8A3, 8A4, 8B1, 8B2, 8B3, 8B4 |
| | 2700 K | E8 | 8A1, 8A2, 8A3, 8A4, 8B1, 8B2, 8B3, 8B4, 8C1, 8C2, 8C3, 8C4, 8D1, 8D2, 8D3, 8D4 |
| | 2700 K | Z8 | 8A3, 8B4, 8C1, 8D2 |

BIN AND ORDER CODE FORMATS

XP-G2 bin codes and order codes are configured in the following manner:

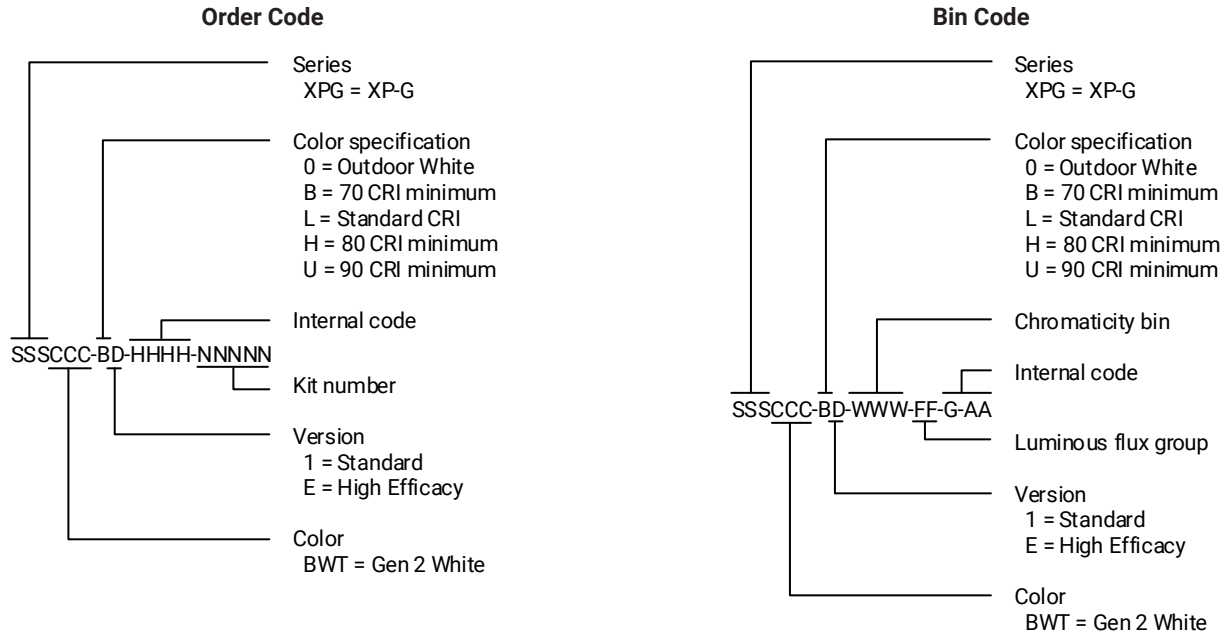

REFLOW SOLDERING CHARACTERISTICS

In testing, Cree LED has found XLamp XP-G2 LEDs to be compatible with JEDEC J-STD-020C, using the parameters listed below. As a general guideline, Cree LED recommends that users follow the recommended soldering profile provided by the manufacturer of the solder paste used, and therefore it is the lamp or luminaire manufacturer’s responsibility to determine applicable soldering requirements.

Note that this general guideline may not apply to all PCB designs and configurations of reflow soldering equipment.

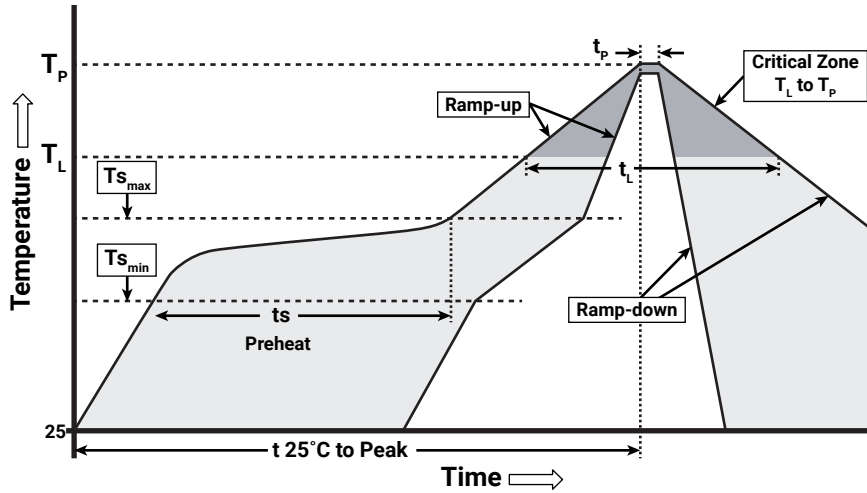

IPC/JEDEC J-STD-020C

| Profile Feature | Lead-Free Solder |
|---|------------------|
| Average Ramp-Up Rate ($T_{s_{max}}$ to T_P) | 1.2 °C/second |
| Preheat: Temperature Min ($T_{s_{min}}$) | 120 °C |
| Preheat: Temperature Max ($T_{s_{max}}$) | 170 °C |
| Preheat: Time ($t_{s_{min}}$ to $t_{s_{max}}$) | 65-150 seconds |
| Time Maintained Above: Temperature (T_L) | 217 °C |
| Time Maintained Above: Time (t_L) | 45-90 seconds |
| Peak/Classification Temperature (T_P) | 235 - 245 °C |
| Time Within 5 °C of Actual Peak Temperature (t_p) | 20-40 seconds |
| Ramp-Down Rate | 1 - 6 °C/second |
| Time 25 °C to Peak Temperature | 4 minutes max. |

Note: All temperatures refer to topside of the package, measured on the package body surface.

NOTES

Measurements

The luminous flux, radiant power, chromaticity, forward voltage and CRI measurements in this document are binning specifications only and solely represent product measurements as of the date of shipment. These measurements will change over time based on a number of factors that are not within Cree LED's control and are not intended or provided as operational specifications for the products. Calculated values are provided for informational purposes only and are not intended or provided as specifications.

Pre-Release Qualification Testing

Please read the [LED Reliability Overview](#) for details of the qualification process Cree LED applies to ensure long-term reliability for XLamp LEDs and details of Cree LED's pre-release qualification testing for XLamp LEDs.

Lumen Maintenance

Cree LED now uses standardized IES LM-80-08 and TM-21-11 methods for collecting long-term data and extrapolating LED lumen maintenance. For information on the specific LM-80 data sets available for this LED, refer to the public [LM-80 results document](#).

Please read the [Long-Term Lumen Maintenance application note](#) for more details on Cree LED's lumen maintenance testing and forecasting. Please read the [Thermal Management application note](#) for details on how thermal design, ambient temperature, and drive current affect the LED junction temperature.

Moisture Sensitivity

Cree LED recommends keeping XLamp LEDs in the provided, resealable moisture-barrier packaging (MBP) until immediately prior to soldering. Unopened MBPs that contain XLamp LEDs do not need special storage for moisture sensitivity.

Once the MBP is opened, XLamp XP-G2 LEDs may be stored as MSL 1 per JEDEC J-STD-033, meaning they have unlimited floor life in conditions of ≤ 30 °C/85% relative humidity (RH). Regardless of the storage condition, Cree LED recommends sealing any unsoldered LEDs in the original MBP.

RoHS Compliance

The levels of RoHS restricted materials in this product are below the maximum concentration values (also referred to as the threshold limits) permitted for such substances, or are used in an exempted application, in accordance with EU Directive 2011/65/EC (RoHS2), as implemented January 2, 2013. RoHS Declarations for this product can be obtained from your Cree LED representative or from the [Product Ecology](#) section of the Cree LED website.

REACH Compliance

REACH substances of very high concern (SVHCs) information is available for this product. Since the European Chemical Agency (ECHA) has published notice of their intent to frequently revise the SVHC listing for the foreseeable future, please contact a Cree LED representative to insure you get the most up-to-date REACH Declaration. REACH banned substance information (REACH Article 67) is also available upon request.

NOTES - CONTINUED

UL® Recognized Component

This product meets the requirements to be considered a UL Recognized Component with Level 4 enclosure consideration. The LED package or a portion thereof has been investigated as a fire and electrical enclosure per ANSI/UL 8750.

Vision Advisory

WARNING: Do not look at an exposed lamp in operation. Eye injury can result. For more information about LEDs and eye safety, please refer to the [LED Eye Safety application note](#).

MECHANICAL DIMENSIONS (T_A = 25 °C)

Thermal vias, if present, are not shown on these drawings.

All measurements are ±.13 mm unless otherwise indicated.

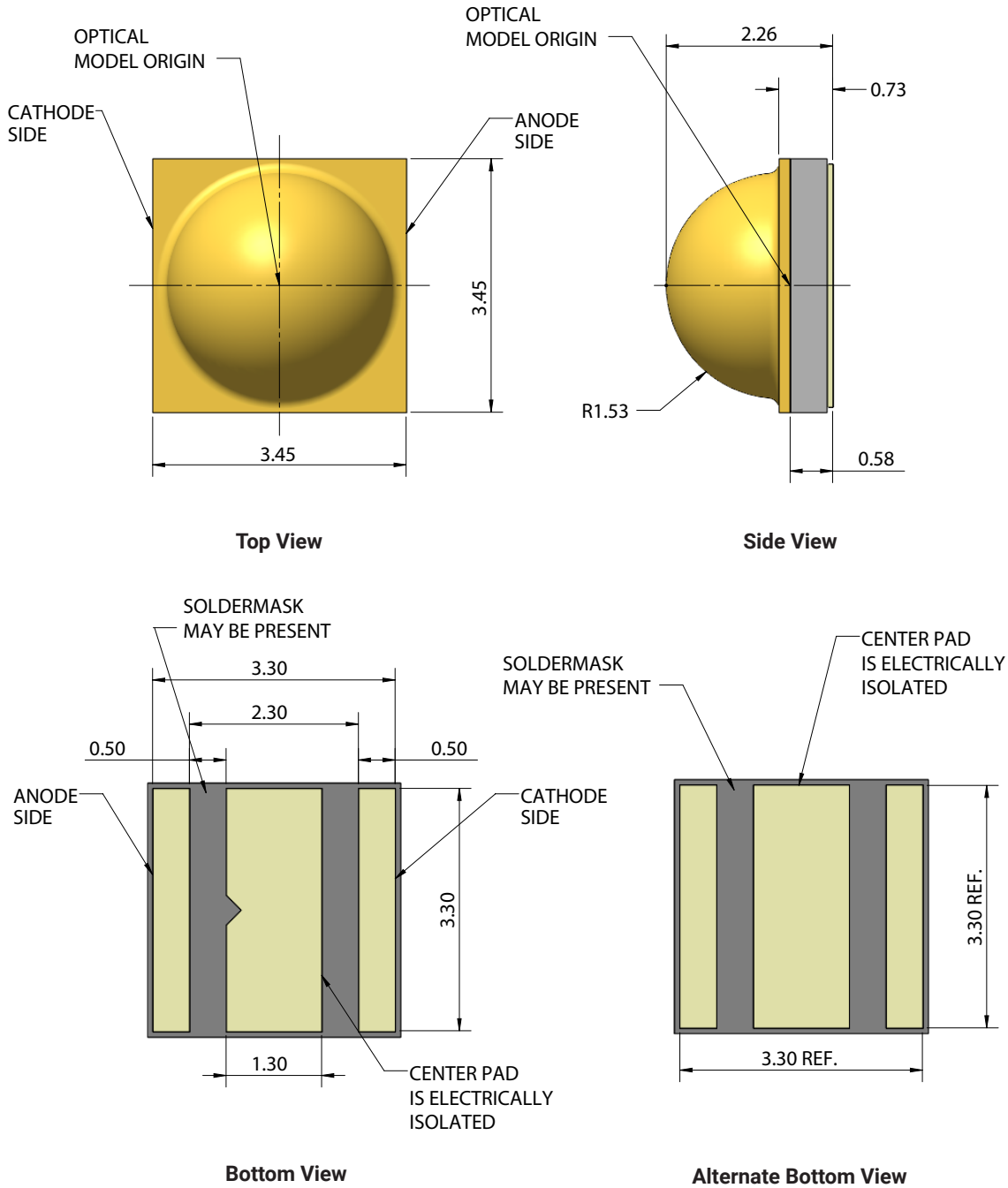

MECHANICAL DIMENSIONS (T_A = 25 °C) - CONTINUED

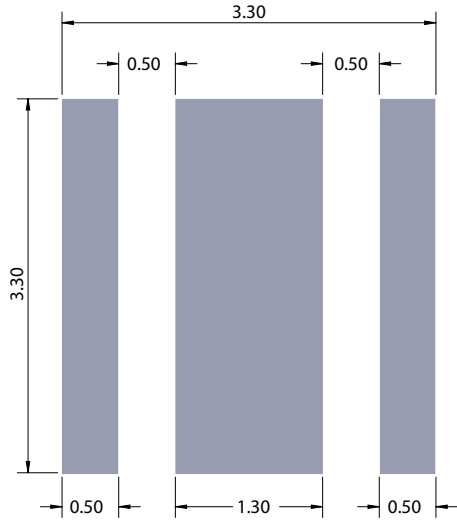

Recommended PCB Footprint

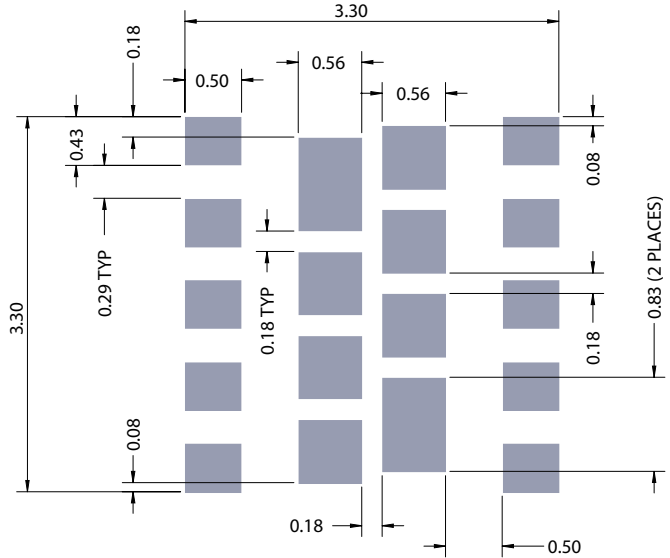

Recommended Stencil Openings*

Notes:

- Cree LED recommends using thermal pad kickouts to maximize component thermal performance.
- Cree LED recommends using white solder mask material to minimize system optical loss.
- * This stencil has been tested and optimized for the avoidance of voiding when using ALPHA® LUMET® P30 Maxrel solder paste. For other solder pastes, a “window pane” design for the thermal pad stencil may result in a lower voiding percentage. Contact your local Cree LED Field Applications Engineer for consultation regarding your specific application.

TAPE AND REEL

All Cree LED carrier tapes conform to EIA-481D, Automated Component Handling Systems Standard.

All dimensions in mm.

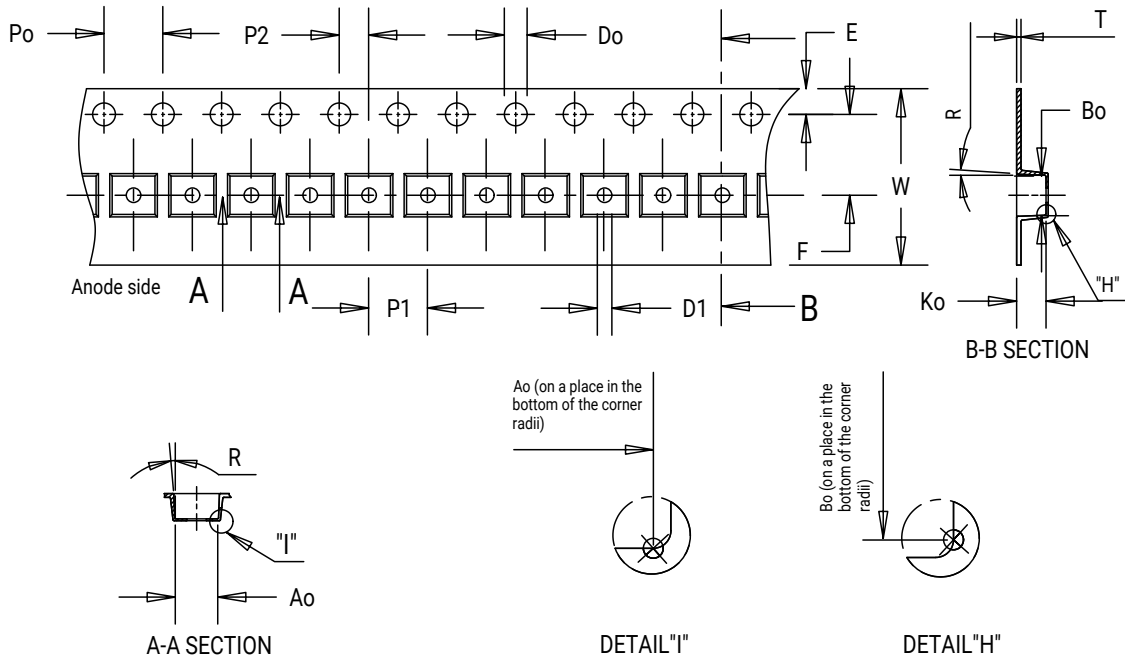

| Item | Ao | Bo | Ko | Po | P1 | P2 | T | E | F | Do | D1 | W | R |
|------|------|------|------|------|------|------|------|------|------|------|------|-------|----|
| Dim. | 3.70 | 3.70 | 2.40 | 4.00 | 8.00 | 2.00 | 0.30 | 1.75 | 5.50 | 1.55 | 1.50 | 12.00 | 5° |

TAPE AND REEL - CONTINUED

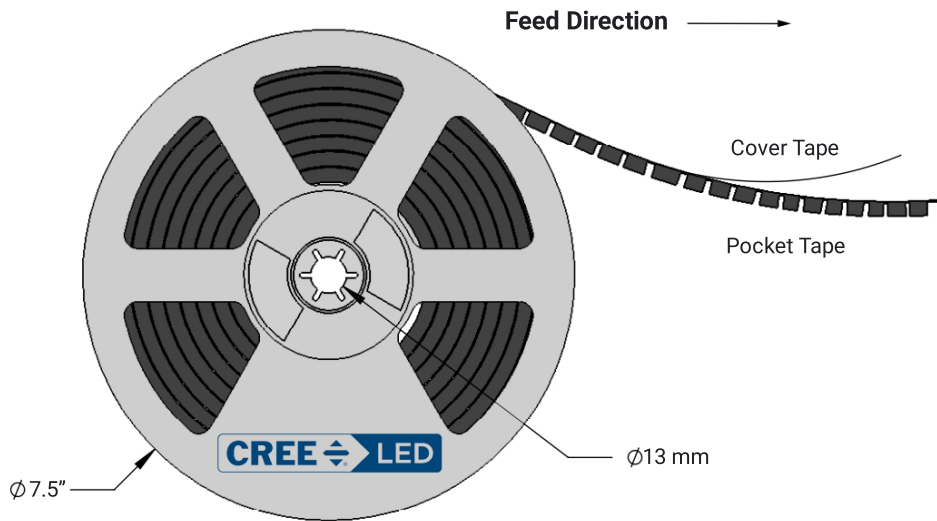
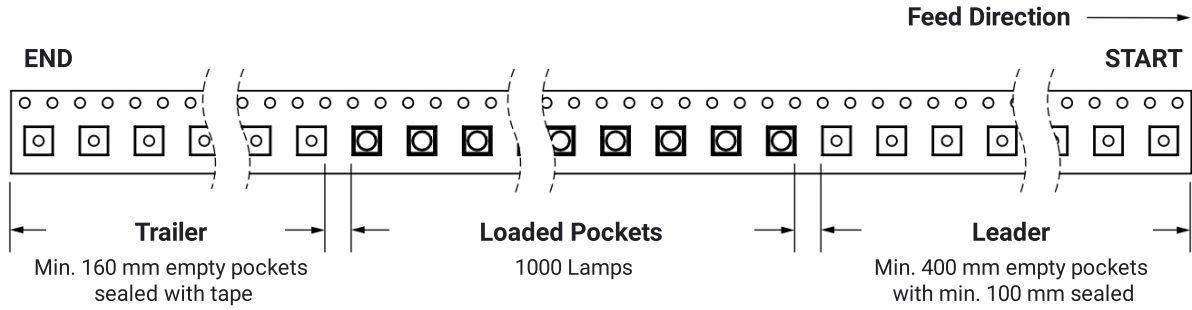

PACKAGING

Unpackaged Reel

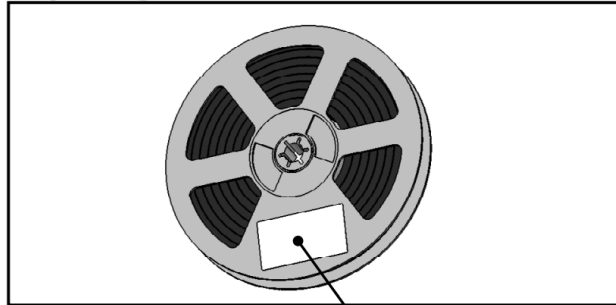

Label with Cree LED Bin Code, Quantity, Reel ID

Packaged Reel

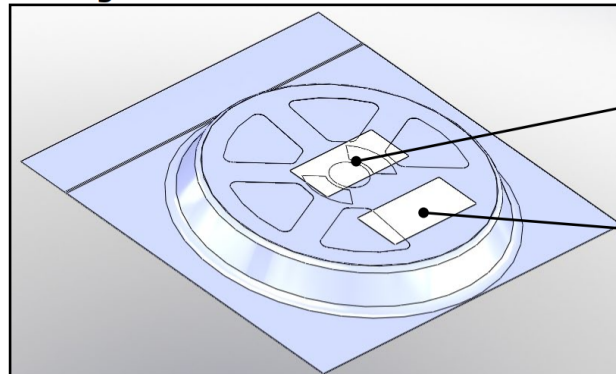

Label with Cree LED Order Code, Quantity, Reel ID, PO#

Label with Cree LED Bin Code, Quantity, Reel ID

Boxed Reel

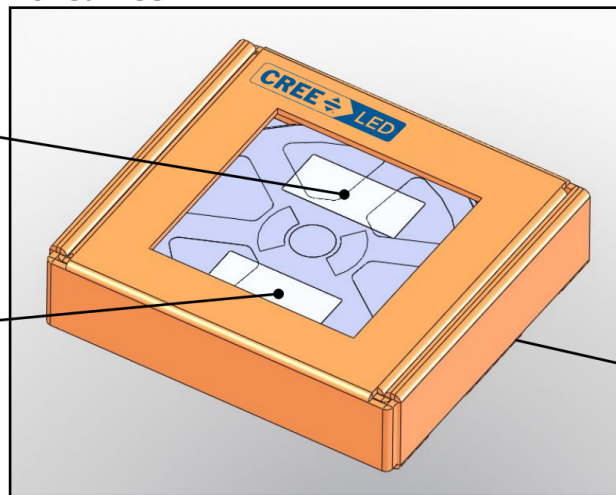

Label with Cree LED Order Code, Quantity, Reel ID, PO#

Label with Cree LED Bin Code, Quantity, Reel ID

Patent Label (on bottom of box)

APPENDIX - ORDER CODES NOT FOR NEW DESIGNS

The following order codes are active and valid order codes, but higher performance options are also available. Please see page 4 - page 9 for order codes of XLamp XP-G2 LEDs that could serve as alternatives for the order codes set forth below.

XP-G2 High Efficacy, T_j = 85 °C

| Chromaticity | | Minimum Luminous Flux (lm) @ 350 mA | | Order Codes | | |
|--------------|--------|-------------------------------------|-----------|----------------------|----------------------|----------------------|
| Kit | CCT | Code | Flux (lm) | 70 CRI Minimum | 80 CRI Minimum | 90 CRI Minimum |
| DT | 7000 K | S2 | 148 | XPGBWT-BE-0000-00JDT | | |
| | | R5 | 139 | | XPGBWT-HE-0000-00HDT | |
| E1 | 6500 K | S2 | 148 | XPGBWT-BE-0000-00JE1 | | |
| | | R5 | 139 | | XPGBWT-HE-0000-00HE1 | |
| 51 | 6200 K | S2 | 148 | XPGBWT-BE-0000-00J51 | | |
| | | R5 | 139 | | XPGBWT-HE-0000-00H51 | |
| DV | 6000 K | S2 | 148 | XPGBWT-BE-0000-00JDV | | |
| | | R5 | 139 | | XPGBWT-HE-0000-00HDV | |
| 50 | 6200 K | S2 | 148 | XPGBWT-BE-0000-00J50 | | |
| | | R5 | 139 | | XPGBWT-HE-0000-00H50 | |
| E2 | 5700 K | S2 | 148 | XPGBWT-BE-0000-00JE2 | | |
| | | R5 | 139 | | XPGBWT-HE-0000-00HE2 | |
| E3 | 5000 K | S2 | 148 | XPGBWT-BE-0000-00JE3 | | |
| | | R5 | 139 | | XPGBWT-HE-0000-00HE3 | |
| | | R4 | 130 | | | |
| | | R3 | 122 | | | |
| | | R2 | 114 | | | XPGBWT-UE-0000-00EE3 |
| F4 | 4750 K | S2 | 148 | XPGBWT-BE-0000-00JF4 | | |
| | | R5 | 139 | | XPGBWT-HE-0000-00HF4 | |
| | | R4 | 130 | | | |
| | | R3 | 122 | | | |
| | | R2 | 114 | | | XPGBWT-UE-0000-00EF4 |
| E4 | 4500 K | S2 | 148 | XPGBWT-BE-0000-00JE4 | | |
| | | R5 | 139 | | XPGBWT-HE-0000-00HE4 | |
| | | R4 | 130 | | | |
| | | R3 | 122 | | | |
| | | R2 | 114 | | | XPGBWT-UE-0000-00EE4 |
| F5 | 4250 K | S2 | 148 | XPGBWT-BE-0000-00JF5 | | |
| | | R5 | 139 | | XPGBWT-HE-0000-00HF5 | |
| | | R4 | 130 | | | |
| | | R3 | 122 | | | |
| | | R2 | 114 | | | XPGBWT-UE-0000-00EF5 |

- Note**
- Cree LED maintains a tolerance of ±7% on flux and power measurements, ±0.005 on chromaticity (CCx, CCy) measurements and a tolerance of ±2 on CRI measurements. See the Measurements section (page 33).

APPENDIX - ORDER CODES NOT FOR NEW DESIGNS - CONTINUED

| Chromaticity | | Minimum Luminous Flux (lm) @ 350 mA | | Order Codes | | |
|--------------|--------|-------------------------------------|-----------|----------------------|----------------------|----------------------|
| Kit | CCT | Code | Flux (lm) | 70 CRI Minimum | 80 CRI Minimum | 90 CRI Minimum |
| E5 | 4000 K | S2 | 148 | XPGBWT-BE-0000-00JE5 | | |
| | | R5 | 139 | | XPGBWT-HE-0000-00HE5 | |
| | | R4 | 130 | | | |
| | | R3 | 122 | | | |
| | | R2 | 114 | | | XPGBWT-UE-0000-00EE5 |
| F6 | 3750 K | S2 | 148 | XPGBWT-BE-0000-00JF6 | | |
| | | R5 | 139 | | XPGBWT-HE-0000-00HF6 | |
| | | R4 | 130 | | | |
| | | R3 | 122 | | | |
| | | R2 | 114 | | | XPGBWT-UE-0000-00EF6 |
| E6 | 3500 K | S2 | 148 | XPGBWT-BE-0000-00JE6 | | |
| | | R5 | 139 | | XPGBWT-HE-0000-00HE6 | |
| | | R4 | 130 | | | |
| | | R3 | 122 | | | |
| | | R2 | 114 | | | XPGBWT-UE-0000-00EF6 |
| F7 | 3250 K | S2 | 148 | XPGBWT-BE-0000-00JF7 | | |
| | | R5 | 139 | XPGBWT-BE-0000-00HF7 | | |
| | | R4 | 130 | | XPGBWT-HE-0000-00GF7 | |
| E7 | 3000 K | S2 | 148 | XPGBWT-BE-0000-00JE7 | | |
| | | R5 | 139 | XPGBWT-BE-0000-00HE7 | | |
| | | R4 | 130 | | XPGBWT-HE-0000-00GE7 | |
| F8 | 2850 K | S2 | 148 | XPGBWT-BE-0000-00JF8 | | |
| | | R5 | 139 | XPGBWT-BE-0000-00HF8 | | |
| | | R4 | 130 | | XPGBWT-HE-0000-00GF8 | |
| | | R3 | 122 | | | |
| | | R2 | 114 | | | |
| | | Q5 | 107 | | | XPGBWT-UE-0000-00DF8 |
| E8 | 2700 K | S2 | 148 | XPGBWT-BE-0000-00JE8 | | |
| | | R5 | 139 | XPGBWT-BE-0000-00HE8 | | |
| | | R4 | 130 | | XPGBWT-HE-0000-00GE8 | |
| | | R3 | 122 | | | |
| | | R2 | 114 | | | |
| | | Q5 | 107 | | | XPGBWT-UE-0000-00DE8 |

- Note**
- Cree LED maintains a tolerance of ±7% on flux and power measurements, ±0.005 on chromaticity (CCx, CCy) measurements and a tolerance of ±2 on CRI measurements. See the Measurements section (page 33).

APPENDIX - ORDER CODES NOT FOR NEW DESIGNS - CONTINUED

The following order codes are active and valid order codes, but higher performance options are also available. Please see page 10 - page 13 for order codes of XLamp XP-G2 LEDs that could serve as alternatives for the order codes set forth below.

XP-G2 Standard T_j = 85 °C

| Chromaticity | | Minimum Luminous Flux (lm) @ 350 mA | | Order Codes |
|--------------|--------|-------------------------------------|-----------|----------------------|
| Kit | CCT | Code | Flux (lm) | 70 CRI Typical |
| 51 | 6200 K | R5 | 139 | XPGBWT-L1-0000-00H51 |
| | | R4 | 130 | XPGBWT-L1-0000-00G51 |
| | | R3 | 122 | XPGBWT-L1-0000-00F51 |
| 53 | 6000 K | R5 | 139 | XPGBWT-L1-0000-00H53 |
| | | R4 | 130 | XPGBWT-L1-0000-00G53 |
| | | R3 | 122 | XPGBWT-L1-0000-00F53 |
| 50 | 6200 K | R5 | 139 | XPGBWT-L1-0000-00H50 |
| | | R4 | 130 | XPGBWT-L1-0000-00G50 |
| | | R3 | 122 | XPGBWT-L1-0000-00F50 |
| E1 | 6500 K | R5 | 139 | XPGBWT-L1-0000-00HE1 |
| | | R4 | 130 | XPGBWT-L1-0000-00GE1 |
| | | R3 | 122 | XPGBWT-L1-0000-00FE1 |
| E2 | 5700 K | R5 | 139 | XPGBWT-L1-0000-00HE2 |
| | | R4 | 130 | XPGBWT-L1-0000-00GE2 |
| | | R3 | 122 | XPGBWT-L1-0000-00FE2 |

| Chromaticity | | Minimum Luminous Flux (lm) @ 350 mA | | Order Codes | |
|--------------|--------|-------------------------------------|-----------|----------------------|----------------|
| Kit | CCT | Code | Flux (lm) | 70 CRI Typical | 80 CRI Minimum |
| E3 | 5000 K | R5 | 139 | XPGBWT-01-0000-00HE3 | |
| | | R4 | 130 | XPGBWT-01-0000-00GE3 | |
| | | R3 | 122 | XPGBWT-01-0000-00FE3 | |
| | | R2 | 114 | XPGBWT-01-0000-00EE3 | |
| F4 | 4750 K | R5 | 139 | XPGBWT-01-0000-00HF4 | |
| | | R4 | 130 | XPGBWT-01-0000-00GF4 | |
| | | R3 | 122 | XPGBWT-01-0000-00FF4 | |
| | | R2 | 114 | XPGBWT-01-0000-00EF4 | |
| E4 | 4500 K | R5 | 139 | XPGBWT-01-0000-00HE4 | |
| | | R4 | 130 | XPGBWT-01-0000-00GE4 | |
| | | R3 | 122 | XPGBWT-01-0000-00FE4 | |
| | | R2 | 114 | XPGBWT-01-0000-00EE4 | |

- Note**
- Cree LED maintains a tolerance of ±7% on flux and power measurements, ±0.005 on chromaticity (CCx, CCy) measurements and a tolerance of ±2 on CRI measurements. See the Measurements section (page 33).

APPENDIX - ORDER CODES NOT FOR NEW DESIGNS - CONTINUED

| Chromaticity | | Minimum Luminous Flux (lm) @ 350 mA | | Order Codes | |
|--------------|---------|-------------------------------------|-----------|----------------------|----------------------|
| Kit | CCT | Code | Flux (lm) | 70 CRI Typical | 80 CRI Minimum |
| F5 | 4250 K | R5 | 139 | XPGBWT-01-0000-00HF5 | |
| | | R4 | 130 | XPGBWT-01-0000-00GF5 | |
| | | R3 | 122 | XPGBWT-01-0000-00FF5 | |
| | | R2 | 114 | XPGBWT-01-0000-00EF5 | |
| E5 | 4000 K | R5 | 139 | XPGBWT-01-0000-00HE5 | |
| | | R4 | 130 | XPGBWT-01-0000-00GE5 | |
| | | R3 | 122 | XPGBWT-01-0000-00FE5 | XPGBWT-H1-0000-00FE5 |
| | | R2 | 114 | XPGBWT-01-0000-00EE5 | XPGBWT-H1-0000-00EE5 |
| | | Q5 | 107 | | XPGBWT-H1-0000-00DE5 |
| Z5 | 4000- K | R3 | 122 | | XPGBWT-H1-0000-00FZ5 |
| | | R2 | 114 | | XPGBWT-H1-0000-00EZ5 |
| | | Q5 | 107 | | XPGBWT-H1-0000-00DZ5 |

| Chromaticity | | Minimum Luminous Flux (lm) @ 350 mA | | Order Codes | | | |
|--------------|--------|-------------------------------------|-----------|----------------------|----------------------|----------------------|----------------|
| Kit | CCT | Code | Flux (lm) | 70 CRI Typical | 80 CRI Typical | 80 CRI Minimum | 90 CRI Minimum |
| F6 | 3750 K | R4 | 130 | XPGBWT-01-0000-00GF6 | | | |
| | | R3 | 122 | XPGBWT-01-0000-00FF6 | XPGBWT-L1-0000-00FF6 | XPGBWT-H1-0000-00FF6 | |
| | | R2 | 114 | XPGBWT-01-0000-00EF6 | XPGBWT-L1-0000-00EF6 | XPGBWT-H1-0000-00EF6 | |
| | | Q5 | 107 | XPGBWT-01-0000-00DF6 | XPGBWT-L1-0000-00DF6 | XPGBWT-H1-0000-00DF6 | |
| E6 | 3500 K | R4 | 130 | XPGBWT-01-0000-00GE6 | | | |
| | | R3 | 122 | XPGBWT-01-0000-00FE6 | XPGBWT-L1-0000-00FE6 | XPGBWT-H1-0000-00FE6 | |
| | | R2 | 114 | XPGBWT-01-0000-00EE6 | XPGBWT-L1-0000-00EE6 | XPGBWT-H1-0000-00EE6 | |
| | | Q5 | 107 | XPGBWT-01-0000-00DE6 | XPGBWT-L1-0000-00DE6 | XPGBWT-H1-0000-00DE6 | |
| Z6 | 3500 K | R3 | 122 | | XPGBWT-L1-0000-00FZ6 | XPGBWT-H1-0000-00FZ6 | |
| | | R2 | 114 | | XPGBWT-L1-0000-00EZ6 | XPGBWT-H1-0000-00EZ6 | |
| | | Q5 | 107 | | XPGBWT-L1-0000-00DZ6 | XPGBWT-H1-0000-00DZ6 | |
| F7 | 3250 K | R4 | 130 | XPGBWT-01-0000-00GF7 | | | |
| | | R3 | 122 | XPGBWT-01-0000-00FF7 | XPGBWT-L1-0000-00FF7 | XPGBWT-H1-0000-00FF7 | |
| | | R2 | 114 | XPGBWT-01-0000-00EF7 | XPGBWT-L1-0000-00EF7 | XPGBWT-H1-0000-00EF7 | |
| | | Q5 | 107 | | XPGBWT-L1-0000-00DF7 | XPGBWT-H1-0000-00DF7 | |

- Note
- Cree LED maintains a tolerance of ±7% on flux and power measurements, ±0.005 on chromaticity (CCx, CCy) measurements and a tolerance of ±2 on CRI measurements. See the Measurements section (page 33).

APPENDIX - ORDER CODES NOT FOR NEW DESIGNS - CONTINUED

| Chromaticity | | Minimum Luminous Flux (lm) @ 350 mA | | Order Codes | | | |
|--------------|--------|-------------------------------------|-----------|----------------------|----------------------|----------------------|----------------------|
| Kit | CCT | Code | Flux (lm) | 70 CRI Typical | 80 CRI Typical | 80 CRI Minimum | 90 CRI Minimum |
| E7 | 3000 K | R3 | 122 | XPGBWT-01-0000-00FE7 | | | |
| | | R2 | 114 | XPGBWT-01-0000-00EE7 | XPGBWT-L1-0000-00EE7 | XPGBWT-H1-0000-00EE7 | |
| | | Q5 | 107 | | XPGBWT-L1-0000-00DE7 | XPGBWT-H1-0000-00DE7 | |
| | | Q4 | 100 | | XPGBWT-L1-0000-00CE7 | XPGBWT-H1-0000-00CE7 | XPGBWT-U1-0000-00CE7 |
| | | Q3 | 93.9 | | | | XPGBWT-U1-0000-00BE7 |
| | | Q2 | 87.4 | | | | XPGBWT-U1-0000-00AE7 |
| | | P4 | 80.6 | | | | XPGBWT-U1-0000-009E7 |
| | | P3 | 73.9 | | | | XPGBWT-U1-0000-008E7 |
| Z7 | 3000 K | R2 | 114 | | XPGBWT-L1-0000-00EZ7 | XPGBWT-H1-0000-00EZ7 | |
| | | Q5 | 107 | | XPGBWT-L1-0000-00DZ7 | XPGBWT-H1-0000-00DZ7 | |
| | | Q4 | 100 | | XPGBWT-L1-0000-00CZ7 | XPGBWT-H1-0000-00CZ7 | XPGBWT-U1-0000-00CZ7 |
| | | Q3 | 93.9 | | | | XPGBWT-U1-0000-00BZ7 |
| | | Q2 | 87.4 | | | | XPGBWT-U1-0000-00AZ7 |
| | | P4 | 80.6 | | | | XPGBWT-U1-0000-009Z7 |
| | | P3 | 73.9 | | | | XPGBWT-U1-0000-008Z7 |
| F8 | 2850 K | R2 | 114 | | XPGBWT-L1-0000-00EF8 | XPGBWT-H1-0000-00EF8 | |
| | | Q5 | 107 | | XPGBWT-L1-0000-00DF8 | XPGBWT-H1-0000-00DF8 | |
| | | Q4 | 100 | | XPGBWT-L1-0000-00CF8 | XPGBWT-H1-0000-00CF8 | XPGBWT-U1-0000-00CF8 |
| | | Q3 | 93.9 | | XPGBWT-L1-0000-00BF8 | XPGBWT-H1-0000-00BF8 | XPGBWT-U1-0000-00BF8 |
| | | Q2 | 87.4 | | | | XPGBWT-U1-0000-00AF8 |
| | | P4 | 80.6 | | | | XPGBWT-U1-0000-009F8 |
| | | P3 | 73.9 | | | | XPGBWT-U1-0000-008F8 |
| | | P2 | 67.2 | | | | XPGBWT-U1-0000-007F8 |
| E8 | 2700 K | R2 | 114 | | XPGBWT-L1-0000-00EE8 | XPGBWT-H1-0000-00EE8 | |
| | | Q5 | 107 | | XPGBWT-L1-0000-00DE8 | XPGBWT-H1-0000-00DE8 | |
| | | Q4 | 100 | | XPGBWT-L1-0000-00CE8 | XPGBWT-H1-0000-00CE8 | |
| | | Q3 | 93.9 | | XPGBWT-L1-0000-00BE8 | XPGBWT-H1-0000-00BE8 | XPGBWT-U1-0000-00BE8 |
| | | Q2 | 87.4 | | | | XPGBWT-U1-0000-00AE8 |
| | | P4 | 80.6 | | | | XPGBWT-U1-0000-009E8 |
| | | P3 | 73.9 | | | | XPGBWT-U1-0000-008E8 |
| | | P2 | 67.2 | | | | XPGBWT-U1-0000-007E8 |
| Z8 | 2700 K | Q5 | 107 | | XPGBWT-L1-0000-00DZ8 | XPGBWT-H1-0000-00DZ8 | |
| | | Q4 | 100 | | XPGBWT-L1-0000-00CZ8 | XPGBWT-H1-0000-00CZ8 | |
| | | Q3 | 93.9 | | XPGBWT-L1-0000-00BZ8 | XPGBWT-H1-0000-00BZ8 | |
| | | Q2 | 87.4 | | | | XPGBWT-U1-0000-00AZ8 |
| | | P4 | 80.6 | | | | XPGBWT-U1-0000-009Z8 |
| | | P3 | 73.9 | | | | XPGBWT-U1-0000-008Z8 |
| | | P2 | 67.2 | | | | XPGBWT-U1-0000-007Z8 |

Note

- Cree LED maintains a tolerance of ±7% on flux and power measurements, ±0.005 on chromaticity (CCx, CCy) measurements and a tolerance of ±2 on CRI measurements. See the Measurements section (page 33).

Mouser Electronics

Authorized Distributor

Click to View Pricing, Inventory, Delivery & Lifecycle Information:

Cree LED:

[XPGBWT-01-0000-00HE4](#) [XPGBWT-H1-R250-00BF8](#) [XPGBWT-H1-R250-00BZ8](#) [XPGBWT-H1-R250-00CE8](#)
[XPGBWT-H1-R250-00DF6](#) [XPGBWT-L1-0000-00F51](#) [XPGBWT-L1-R250-00DZ5](#) [XPGBWT-L1-R250-00FE3](#)
[XPGBWT-01-R250-00GE4](#) [XPGBWT-H1-0000-00EF6](#) [XPGBWT-H1-R250-00CZ6](#) [XPGBWT-L1-R250-00EZ5](#)
[XPGBWT-L1-R250-00FE1](#) [XPGBWT-01-0000-00FC1](#) [XPGBWT-01-0000-00FE6](#) [XPGBWT-01-0000-00FF5](#) [XPGBWT-](#)
[H1-0000-00DE5](#) [XPGBWT-H1-R250-00EF6](#) [XPGBWT-L1-0000-00HE1](#) [XPGBWT-L1-R250-00FF5](#) [XPGBWT-L1-](#)
[R250-00CZ7](#) [XPGBWT-01-0000-00HE3](#) [XPGBWT-H1-0000-00DE7](#) [XPGBWT-H1-0000-00EE5](#) [XPGBWT-H1-R250-](#)
[00CF8](#) [XPGBWT-L1-0000-00CF8](#) [XPGBWT-L1-R250-00DF5](#) [XPGBWT-L1-R250-00DZ6](#) [XPGBWT-L1-R250-00DZ7](#)
[XPGBWT-01-0000-00DF6](#) [XPGBWT-01-0000-00EC1](#) [XPGBWT-01-0000-00EE3](#) [XPGBWT-01-0000-00EE4](#)
[XPGBWT-01-0000-00EE6](#) [XPGBWT-01-0000-00EF4](#) [XPGBWT-01-0000-00EF5](#) [XPGBWT-01-0000-00EF6](#) [XPGBWT-](#)
[01-0000-00FE3](#) [XPGBWT-01-0000-00FE4](#) [XPGBWT-01-0000-00FE5](#) [XPGBWT-01-0000-00FF4](#) [XPGBWT-01-0000-](#)
[00FF6](#) [XPGBWT-01-0000-00GC1](#) [XPGBWT-01-0000-00GE3](#) [XPGBWT-01-0000-00GE4](#) [XPGBWT-01-0000-00GE5](#)
[XPGBWT-01-0000-00GF4](#) [XPGBWT-01-0000-00GF5](#) [XPGBWT-01-0000-00HC1](#) [XPGBWT-01-0000-00HF4](#)
[XPGBWT-01-R250-00DE6](#) [XPGBWT-01-R250-00DF6](#) [XPGBWT-01-R250-00EE3](#) [XPGBWT-01-R250-00EE4](#)
[XPGBWT-01-R250-00EE5](#) [XPGBWT-01-R250-00EE6](#) [XPGBWT-01-R250-00EF4](#) [XPGBWT-01-R250-00EF5](#)
[XPGBWT-01-R250-00EF6](#) [XPGBWT-01-R250-00FE3](#) [XPGBWT-01-R250-00FE4](#) [XPGBWT-01-R250-00FE5](#)
[XPGBWT-01-R250-00FE6](#) [XPGBWT-01-R250-00FF4](#) [XPGBWT-01-R250-00FF5](#) [XPGBWT-01-R250-00FF6](#)
[XPGBWT-01-R250-00GE3](#) [XPGBWT-01-R250-00GE5](#) [XPGBWT-01-R250-00GF4](#) [XPGBWT-01-R250-00GF5](#)
[XPGBWT-01-R250-00HE3](#) [XPGBWT-01-R250-00HE4](#) [XPGBWT-01-R250-00HF4](#) [XPGBWT-H1-0000-00BE8](#)
[XPGBWT-H1-0000-00BF8](#) [XPGBWT-H1-0000-00BZ8](#) [XPGBWT-H1-0000-00CE7](#) [XPGBWT-H1-0000-00CE8](#)
[XPGBWT-H1-0000-00CF7](#) [XPGBWT-H1-0000-00CF8](#) [XPGBWT-H1-0000-00CZ7](#) [XPGBWT-H1-0000-00CZ8](#)
[XPGBWT-H1-0000-00DE6](#) [XPGBWT-H1-0000-00DF6](#) [XPGBWT-H1-0000-00DF7](#) [XPGBWT-H1-0000-00DZ5](#)
[XPGBWT-H1-0000-00DZ6](#) [XPGBWT-H1-0000-00DZ7](#) [XPGBWT-H1-0000-00EZ5](#) [XPGBWT-H1-R250-00BE8](#)
[XPGBWT-H1-R250-00CE6](#) [XPGBWT-H1-R250-00CE7](#) [XPGBWT-H1-R250-00CF7](#) [XPGBWT-H1-R250-00CZ7](#)
[XPGBWT-H1-R250-00CZ8](#) [XPGBWT-H1-R250-00DE5](#) [XPGBWT-H1-R250-00DE6](#) [XPGBWT-H1-R250-00DE7](#)
[XPGBWT-H1-R250-00DF7](#) [XPGBWT-H1-R250-00DZ5](#)